

INTERNATIONAL STANDARD

IEC
62287-1

First edition
2006-03

**Maritime navigation and radiocommunication
equipment and systems –
Class B shipborne equipment of the
automatic identification system (AIS) –**

**Part 1:
Carrier-sense time division multiple access
(CSTDMA) techniques**



Reference number
IEC 62287-1:2006(E)

Publication numbering

As from 1 January 1997 all IEC publications are issued with a designation in the 60000 series. For example, IEC 34-1 is now referred to as IEC 60034-1.

Consolidated editions

The IEC is now publishing consolidated versions of its publications. For example, edition numbers 1.0, 1.1 and 1.2 refer, respectively, to the base publication, the base publication incorporating amendment 1 and the base publication incorporating amendments 1 and 2.

Further information on IEC publications

The technical content of IEC publications is kept under constant review by the IEC, thus ensuring that the content reflects current technology. Information relating to this publication, including its validity, is available in the IEC Catalogue of publications (see below) in addition to new editions, amendments and corrigenda. Information on the subjects under consideration and work in progress undertaken by the technical committee which has prepared this publication, as well as the list of publications issued, is also available from the following:

- **IEC Web Site** (www.iec.ch)

- **Catalogue of IEC publications**

The on-line catalogue on the IEC web site (www.iec.ch/searchpub) enables you to search by a variety of criteria including text searches, technical committees and date of publication. On-line information is also available on recently issued publications, withdrawn and replaced publications, as well as corrigenda.

- **IEC Just Published**

This summary of recently issued publications (www.iec.ch/online_news/justpub) is also available by email. Please contact the Customer Service Centre (see below) for further information.

- **Customer Service Centre**

If you have any questions regarding this publication or need further assistance, please contact the Customer Service Centre:

Email: custserv@iec.ch
Tel: +41 22 919 02 11
Fax: +41 22 919 03 00

INTERNATIONAL STANDARD

IEC 62287-1

First edition
2006-03

Maritime navigation and radiocommunication equipment and systems – Class B shipborne equipment of the automatic identification system (AIS) –

Part 1: Carrier-sense time division multiple access (CSTDMA) techniques

© IEC 2006 — Copyright - all rights reserved

No part of this publication may be reproduced or utilized in any form or by any means, electronic or mechanical, including photocopying and microfilm, without permission in writing from the publisher.

International Electrotechnical Commission, 3, rue de Varembé, PO Box 131, CH-1211 Geneva 20, Switzerland
Telephone: +41 22 919 02 11 Telefax: +41 22 919 03 00 E-mail: inmail@iec.ch Web: www.iec.ch



Commission Electrotechnique Internationale
International Electrotechnical Commission
Международная Электротехническая Комиссия

PRICE CODE

XC

For price, see current catalogue

CONTENTS

FOREWORD.....	5
INTRODUCTION.....	7
1 Scope.....	8
2 Normative references	8
3 Abbreviations	9
4 General requirements	10
4.1 General	10
4.2 Manuals	12
4.3 Marking and identification.....	12
5 Environmental, power supply, interference and safety requirements	12
6 Performance requirements	13
6.1 Composition	13
6.2 Operating frequency channels	13
6.3 GNSS receiver for position reporting	13
6.4 Identification.....	14
6.5 AIS information	14
6.6 Alarms and indications, fall-back arrangements.....	15
6.7 User interface.....	17
7 Technical requirements	17
7.1 General	17
7.2 Physical layer	18
7.3 Link layer	21
7.4 Network layer	36
7.5 Transport layer	38
7.6 Digital Selective Calling (DSC).....	38
8 Test conditions	38
8.1 General	38
8.2 Normal and extreme test conditions.....	38
8.3 Test signals.....	39
8.4 Test arrangements	40
9 Power supply, environmental and EMC tests	42
9.1 Test summary	42
9.2 Vibration/shock	43
9.3 Performance tests/checks	44
9.4 Undervoltage test (brown out)	44
10 Operational tests	45
10.1 General	45
10.2 Modes of operation.....	45
10.3 Messages extending one time period.....	48
10.4 Channel selection.....	48
10.5 Internal GNSS receiver.....	49
10.6 AIS information	49
10.7 Initialisation period	52
10.8 Alarms and indications, fall-back arrangements.....	52
10.9 User interface.....	53

11	Physical tests	55
11.1	TDMA transmitter	55
11.2	TDMA receivers	59
11.3	Conducted spurious emissions	66
12	Specific tests of link layer	67
12.1	TDMA synchronisation	67
12.2	Carrier-sense tests	68
12.3	VDL state/reservations	70
12.4	Data encoding (bit stuffing)	70
12.5	Frame check sequence	71
12.6	Slot allocation (channel access protocol)	71
12.7	Assigned operation	72
12.8	Message formats	73
13	Specific tests of network layer	74
13.1	Regional area designation by VDL message	74
13.2	Regional area designation by serial message or manually	75
13.3	Management of received regional operating settings	75
	Annex A (informative) Results of computer simulations and testing of CSTDMA technology ..	78
	Annex B (informative) Description of the system	81
	Annex C (normative) DSC channel management	82
	Annex D (informative) Channel management regions	89
	Figure 1 – OSI layer model	18
	Figure 2 – Carrier-Sense timing	22
	Figure 3 – Power versus time mask	23
	Figure 4 – Transmission packet	24
	Figure 5 – Training sequence	26
	Figure 6 – Transmission timing	28
	Figure 7 – Example for CSTDMA access	29
	Figure 8 – Format for repeating four-packet cluster	40
	Figure 9 – Measurement arrangement for carrier power	55
	Figure 10 – Emission mask	56
	Figure 11 – Measurement arrangement for modulation accuracy	57
	Figure 12 – Measurement arrangement	59
	Figure 13 – Measurement arrangement with two generators	60
	Figure 14 – SINAD or PER/BER Measuring Equipment	62
	Figure 15 – Measurement arrangement for intermodulation	64
	Figure 16 – Configuration for Carrier-Sense threshold test	69
	Figure 17 – Regional area scenario	74
	Figure A.1 – Effect on Class A AIS messages of Class B messages	78
	Figure A.2 – Reception of messages by Class A AIS	79
	Figure A.3 – Reception of messages by Class B AIS	79
	Figure A.4 – Range achieved by a Class A AIS from Class B AIS	80
	Figure D.1 – Channel management regions used for test given in 13.3.1	89

Table 1 – Position sensor fallback conditions	16
Table 2 – Use of accuracy (PA) flag	16
Table 3 – Transceiver characteristics	19
Table 4 – Transmitter parameters	20
Table 5 – Receiver parameters	21
Table 6 – Definition of timings for Figure 3.....	23
Table 7 – Start-buffer	25
Table 8 – Summary of the transmission packet	27
Table 9 – Transmission timing	27
Table 10 – Access parameters.....	29
Table 11 – Use of VDL messages by a Class B"CS" AIS.....	32
Table 12 – Number of data bits for use with Message 14	33
Table 13 – Contents of Message 18.....	33
Table 14 – Message 24 Part A:.....	34
Table 15 – Message 24 Part B:.....	35
Table 16 – Contents of Message 23.....	35
Table 17 – Reporting Interval Settings for use with Message 23	36
Table 18 – Channel management	37
Table 19 – Content of first two packets	40
Table 20 – Fixed PRS data derived from ITU-T.O.153	40
Table 21 – Test summary	42
Table 22 – Peak frequency deviation versus time	58
Table 23 – Frequencies for inter-modulation test	65
Table 24 – Required threshold test results	69
Table 25 – Required carrier sense timing results	70
Table 26 – Required channels in use	75
Table C.1 – DSC monitoring times	83

INTERNATIONAL ELECTROTECHNICAL COMMISSION

**MARITIME NAVIGATION AND RADIOCOMMUNICATION
EQUIPMENT AND SYSTEMS –
CLASS B SHIPBORNE EQUIPMENT OF THE
AUTOMATIC IDENTIFICATION SYSTEM (AIS) –**

**Part 1: Carrier-sense time division multiple access
(CSTDMA) techniques**

FOREWORD

- 1) The International Electrotechnical Commission (IEC) is a worldwide organization for standardization comprising all national electrotechnical committees (IEC National Committees). The object of IEC is to promote international co-operation on all questions concerning standardization in the electrical and electronic fields. To this end and in addition to other activities, IEC publishes International Standards, Technical Specifications, Technical Reports, Publicly Available Specifications (PAS) and Guides (hereafter referred to as "IEC Publication(s)"). Their preparation is entrusted to technical committees; any IEC National Committee interested in the subject dealt with may participate in this preparatory work. International, governmental and non-governmental organizations liaising with the IEC also participate in this preparation. IEC collaborates closely with the International Organization for Standardization (ISO) in accordance with conditions determined by agreement between the two organizations.
- 2) The formal decisions or agreements of IEC on technical matters express, as nearly as possible, an international consensus of opinion on the relevant subjects since each technical committee has representation from all interested IEC National Committees.
- 3) IEC Publications have the form of recommendations for international use and are accepted by IEC National Committees in that sense. While all reasonable efforts are made to ensure that the technical content of IEC Publications is accurate, IEC cannot be held responsible for the way in which they are used or for any misinterpretation by any end user.
- 4) In order to promote international uniformity, IEC National Committees undertake to apply IEC Publications transparently to the maximum extent possible in their national and regional publications. Any divergence between any IEC Publication and the corresponding national or regional publication shall be clearly indicated in the latter.
- 5) IEC provides no marking procedure to indicate its approval and cannot be rendered responsible for any equipment declared to be in conformity with an IEC Publication.
- 6) All users should ensure that they have the latest edition of this publication.
- 7) No liability shall attach to IEC or its directors, employees, servants or agents including individual experts and members of its technical committees and IEC National Committees for any personal injury, property damage or other damage of any nature whatsoever, whether direct or indirect, or for costs (including legal fees) and expenses arising out of the publication, use of, or reliance upon, this IEC Publication or any other IEC Publications.
- 8) Attention is drawn to the Normative references cited in this publication. Use of the referenced publications is indispensable for the correct application of this publication.
- 9) Attention is drawn to the possibility that some of the elements of this IEC Publication may be the subject of patent rights. IEC shall not be held responsible for identifying any or all such patent rights.

International Standard IEC 62287-1 has been prepared by IEC technical committee 80: Maritime navigation and radiocommunication equipment and systems.

The text of this standard is based on the following documents:

FDIS	Report on voting
80/426/FDIS	80/434/RVD

Full information on the voting for the approval of this standard can be found in the report on voting indicated in the above table.

This publication has been drafted in accordance with the ISO/IEC Directives, Part 2.

IEC 62287 consists of the following parts, under the general title *Maritime navigation and radiocommunication and systems – Class B shipborne equipment of the automatic identification system (AIS)*

Part 1: Carrier-sense time division multiple access (CSTDMA) techniques

Part 2: Self-organising time division multiple access (SOTDMA) techniques

The committee has decided that the contents of this publication will remain unchanged until the maintenance result date indicated on the IEC web site under "<http://webstore.iec.ch>" in the data related to the specific publication. At this date, the publication will be

- reconfirmed,
- withdrawn,
- replaced by a revised edition, or
- amended.

A bilingual version of this publication may be issued at a later date.

INTRODUCTION

In the ITU Radiocommunications Sector Recommendation ITU-R M.1371-1 "Technical characteristics for a universal shipborne Automatic Identification System (AIS) using SOTDMA (Self-Organising Time Division Multiple Access) in the VHF maritime mobile band", provision is made for a Class B AIS for use on craft not covered by a mandatory carriage requirement under SOLAS Chapter V, Regulation 19. This part of IEC 62287 sets out the requirements, methods of test and required test results for such a Class B AIS.

The International Maritime Organization (IMO), in its Resolution MSC.140(76), recognised that the radio channels used by AIS, particularly AIS 1 (161,975 MHz) and AIS 2 (162,025 MHz), are regarded as an AIS network, and any disruption to those channels by any one AIS device could affect the operation of all AIS devices on that network. IMO also recognised that Administrations should take steps necessary to ensure the integrity of the radio channels used for AIS in their waters.

IEC Technical Committee 80 (TC 80) allocated a new work item 80/287/NP to Working Group 8a (WG 8a), tasking them with producing a test standard for Class B AIS equipment. During the development of this test standard, Administrations expressed concern that large numbers of Class B AIS equipped vessels could have a detrimental effect on the safe operation of the AIS network by SOLAS Class A vessels, Base Stations and AIS on Aids to Navigation (AtoN AIS). As a result, a new network access technology was developed, which allows large numbers of Class B fitted vessels to coexist with Class A with a negligible detrimental effect on AIS network.

The new technology, hereinafter referred to as "Carrier-Sense TDMA (CSTDMA)", requires that the Class B "CS" AIS listens to the AIS network to determine if the network is free of activity and, only if the network is free, can it transmit its information. This Class B AIS is also required to listen for reservations from base stations and comply with these reservations. This polite operation ensures that this Class B AIS minimises the probability of interference with Class A, Base Station or AtoN AIS operations. Extensive computer models simulation and practical laboratory testing and sea trials were undertaken to validate CSTDMA during its development (see Annex A).

WG8a recognised that the primary function of a Class B AIS is for fitted vessels to be visible and participate in the AIS network. CSTDMA was designed to fulfil these requirements.

This Class B AIS is backward compatible with ITU-R Recommendation M.1371-1 (see Annex B).

**MARITIME NAVIGATION AND RADIOCOMMUNICATION
EQUIPMENT AND SYSTEMS –
CLASS B SHIPBORNE EQUIPMENT OF THE
AUTOMATIC IDENTIFICATION SYSTEM (AIS) –**

**Part 1: Carrier-sense time division multiple access
(CSTDMA) techniques**

1 Scope

This part of IEC 62287 specifies the minimum operational and performance requirements, methods of testing and required test results for Class B shipborne AIS equipment using CSTDMA techniques. This standard takes into account other associated IEC International Standards and existing national standards, as applicable.

It is applicable for AIS equipment used on craft that are not covered by the mandatory carriage requirement of AIS under SOLAS Chapter V.

An AIS station intended to operate in receive-only mode shall not be considered a Class B shipborne mobile AIS station.

2 Normative references

The following referenced documents are indispensable for the application of this document. For dated references, only the edition cited applies. For undated references, the latest edition of the referenced document (including any amendments) applies.

IEC 60945, *Maritime navigation and radiocommunication equipment and systems – General requirements – Methods of testing and required test results*

IEC 61108-1, *Maritime navigation and radiocommunication equipment and systems – Global navigation satellite systems (GNSS) – Part 1: Global positioning system (GPS) – Receiver equipment – Performance standards, methods of testing and required test results*

IEC 61162 (all parts), *Maritime navigation and radiocommunication equipment and systems – Digital interfaces*

IEC 61993-1, *Maritime navigation and radiocommunication equipment and systems – Part 1: Shipborne automatic transponder system installation using VHF digital selective calling (DSC) techniques – Operational and performance requirements, methods of testing and required test results*

IEC 61993-2, *Maritime navigation and radiocommunication equipment and systems – Automatic identification systems (AIS) – Part 2: Class A shipborne equipment of the universal automatic identification system (AIS) – Operational and performance requirements, methods of test and required test results*

ISO/IEC 3309:1993, *Information technology – Telecommunications and information exchange between systems – High-level data link control (HDLC) procedures – Frame structure*

IMO MSC.140(76), *Recommendation for the protection of the AIS VHF data link*

ITU-R Recommendation M.493-11, *Digital selective-calling system for use in the maritime mobile service*

ITU-R Recommendation M.825-3, *Characteristics of a transponder system using digital selective calling techniques for use with vessel traffic services and ship-to-ship identification*

ITU-R Recommendation M.1084-4, *Interim solutions for improved efficiency in the use of the band 156-174 MHz by stations in the maritime mobile service*

ITU-R Recommendation M.1371-1, *Technical characteristics for a universal shipborne automatic identification system using time division multiple access in the VHF maritime mobile band*

ITU-T Recommendation O.153, *Basic parameters for the measurement of error performance at bit rates below the primary rate*

3 Abbreviations

AIS	Automatic Identification System
BER	Bit Error Rate
BT	Bandwidth Time product
COG	Course over ground
CPU	Central Processing Unit
CRC	Cyclic Redundancy Check
CS	Carrier-Sense
CSTDMA	Carrier-Sense Time Division Multiple Access
DGNSS	Differential Global Navigation Satellite System
DLS	Data Link Service
DSC	Digital Selective Calling
ECDIS	Electronic Chart Display and Information System
EPFS	Electronic Position Fixing System
ETA	Estimated Time of Arrival
EUT	Equipment Under Test
FCS	Frame Check Sequence
FM	Frequency Modulation
GMSK	Gaussian Minimum Shift Keying
GNSS	Global Navigation Satellite System
HDG	Heading
HDLC	High level Data Link Control
HSC	High Speed Craft
IHO	International Hydrographic Office
IMO	International Maritime Organization
LME	Link Management Entity
LR	Long Range
MAC	Medium Access Control
MMSI	Maritime Mobile Service Identity
NM	Nautical Miles (refer to ISO 19018)

NRZI	Non Return to Zero Inverted
NUC	Not Under Command
OSI	Open System Interconnection model
P_{ss}	Steady state RF output power
PER	Packet Error Rate
PI	Presentation Interface
PRS	Pseudo Random Sequence
RAIM	Receiver Autonomous Integrity Monitoring
RF	Radio Frequency
Rx	Receive
SINAD	Signal Interference Noise and Distortion ratio
SOG	Speed Over Ground
SOLAS	International Convention for the Safety of Life at Sea
TDMA	Time Division Multiple Access
Tx	Transmit
UTC	Universal Time Co-ordinated
VDL	VHF Data Link
VDM	Serial output message containing VDL information (IEC 61162-1)
VHF	Very High Frequency
VSWR	Voltage Standing Wave Ratio
VTS	Vessel Traffic Services

NOTE Abbreviations related to IEC 61162 series are not included in the above list. For their meaning refer to that standard.

4 General requirements

4.1 General

4.1.1 Capabilities of the Class B“CS” AIS

The Class B“CS” AIS shall improve the safety of navigation by assisting in the efficient navigation of ships and small craft, protection of the environment, and operation of Vessel Traffic Services (VTS). Small craft are vessels which are not required to comply with the mandatory carriage requirements of SOLAS Chapter V, Regulation 19.

The Class B“CS” AIS shall be capable of providing information from small craft, automatically, continuously and with the required accuracy and update rate:

- in a ship-to-ship mode for collision avoidance;
- as a means for littoral States to obtain information about the craft; and
- as a VTS tool, i.e. ship-to-shore (traffic management).

The Class B“CS” AIS station shall be inter-operable and compatible with Class A or other Class B shipborne mobile AIS stations or any other AIS station operating on the AIS VHF Data Link. In particular, Class B“CS” AIS stations shall receive other stations, shall be received by other stations and shall not degrade the integrity of the AIS VHF Data Link.

The Class B“CS” AIS shall only transmit if it has verified that the time period intended for transmission does not interfere with transmissions made by equipment complying with

IEC 61993-2 and from Base Stations. Transmissions of the Class B"CS" AIS shall not exceed one nominal time period (except when responding to a Base station with Message 19).

4.1.2 Quality assurance

Manufacturers shall have a quality control system¹ audited by a competent authority to ensure continuous compliance with the requirements of this standard. Alternatively, the manufacturer may use final product verification procedures where a competent authority verifies compliance with the requirements of this standard before the product is put to the market.

4.1.3 Safety of operation

It shall not be possible for the operator to augment, amend or erase any program software in the equipment required for operation in accordance with the equipment standard. Data used during operation and stored in the system shall be protected in such a way, that necessary modifications and amendments by the user cannot affect its integrity and correctness.

4.1.4 Additional features

Where equipment provides a facility that is additional to the minimum requirements of this standard, the operation and, as far as is reasonably practicable, the malfunction of such an additional facility shall not degrade the performance of the equipment.

4.1.5 Modes of operation

The system shall be capable of operating in a number of modes as described below subject to the transmission of messages by a competent authority. It shall not retransmit received messages.

4.1.5.1 Autonomous and continuous mode

An "autonomous and continuous" mode for operation in all areas transmitting Message 18 for scheduled position reporting and Message 24 for static data.

The Class B"CS" AIS shall be able to receive and process messages at any time except during time periods of transmission.

4.1.5.2 Assigned mode

An "assigned" mode for operation in an area subject to a competent authority responsible for traffic monitoring so that the reporting interval, silent mode and/or transceiver behaviour may be set remotely by that authority using group assignment by Message 23.

4.1.5.3 Interrogation mode

A "polling" or "controlled" mode where the Class B"CS" AIS responds to interrogations by Messages 18 and 24 from a Class A AIS or a Base Station. A Base Station interrogation for Message 19 specifying transmission offset shall also be answered². An interrogation overrides a silent period defined by Message 23 (see 7.3.3.3.3).

A Class B"CS" AIS shall not interrogate other stations.

¹ ISO 9000 series, as applicable, meets this requirement.

² Note that because Message 19 is a message occupying two time periods, this requires the reservation of the respective time periods by Message 20 prior to interrogation.

4.2 Manuals

The manuals shall include:

- the type of external connectors if applicable;
- the required information for correct siting of the antennas;
- the required information for compass safe distance.

4.3 Marking and identification

Each unit of the equipment shall be marked externally with the following information which, where practicable, shall be clearly visible when the equipment is installed in its recommended position:

- identification of the manufacturer;
- equipment type number or model identification;
- serial number of the unit;
- power supply requirements; and
- compass safe distance.

Alternatively, the marking may be presented on a display at equipment start-up.

The version of software shall be either marked or displayed on command on the equipment.

When the marking and the title and version of the software are presented only on the display, such information shall also be included in the equipment manual.

5 Environmental, power supply, interference and safety requirements

In addition to the specific requirements of this standard, the Class B“CS” AIS shall fulfil the following general requirements as detailed in IEC 60945:

- inter-unit connection (interfaces other than IEC 61162 are allowed; see 6.7.3);
- power supply;
- extreme power supply;
- excessive conditions;
- power supply short-term variation and power supply failure (the Class B“CS” AIS shall not enter an undefined or unstable state in case of undervoltage);
- durability and resistance to environmental conditions;
- interference;
- electromagnetic compatibility;
- compass safe distance;
- safety precautions;
- protection against accidental access to dangerous voltages;
- electromagnetic radiofrequency radiation;
- X-radiation.

The manufacturer shall declare the category of the equipment as follows:

- a) portable;
- b) protected from the weather;
- c) exposed to the weather;
- d) submerged or in continuous contact with sea water.

6 Performance requirements

6.1 Composition

The B“CS” AIS shall comprise:

- a communication processor, capable of operating in a part of the VHF Maritime Mobile Service band, in support of short range (VHF) applications;
- at least one transmitter and three receiving processes, two for TDMA and one for DSC on channel 70. The DSC process may use the receiving resources on a time-share basis as described in 7.2.1.6. Outside the DSC receiving periods, the two TDMA receiving processes shall work independently and simultaneously on AIS channel A and channel B³;
- a means for automatic channel switching in the maritime mobile band (by Message 22 and DSC). Manual channel switching shall not be provided;
- an internal GNSS position sensor, which provides a resolution of one ten thousandth of a minute of arc and uses the WGS-84 datum (see 6.3).

6.2 Operating frequency channels

The Class B“CS” AIS shall operate on the frequency channels with 25 kHz bandwidth at least in the range from 161,500 MHz to 162,025 MHz of the ITU Radio Regulations Appendix 18 and in accordance with ITU-R Recommendation M.1084, Annex 4. The DSC receiving process shall be tuned to channel 70.

The Class B“CS” AIS shall automatically revert to receive-only mode on the channels AIS 1 and AIS 2 when commanded to change to frequency channels outside its operating range and/or bandwidth.

6.3 GNSS receiver for position reporting

The Class B“CS” AIS shall have an internal GNSS receiver as a source for position, COG and SOG.

The internal GNSS receiver shall meet the following requirements of IEC 61108-1:

- position accuracy; static and dynamic (5 s);
- COG/SOG accuracy;
- position update (5 s);
- interference susceptibility, and
- status indications (RAIM optional).

The internal GNSS receiver may be capable of being differentially corrected, for example by evaluation of Message 17.

³ In some regions, the competent authority may not require DSC functionality.

An input port for an external GNSS receiver may be provided. The data of an external GNSS receiver shall only be used if:

- the manufacturer has stated, in the installation handbook, that this equipment shall only be connected to a position source that is using WGS-84 datum;
- a valid RAIM sentence (GBS) is received and indicates an expected error of less than 10 m in LAT or LON;
- the external position is within 26 m of the internal position, and
- the input format complies with IEC 61162-1 including mode indicator and checksum.

6.4 Identification

For the purpose of ship and message identification, the appropriate Maritime Mobile Service Identity (MMSI) number shall be used. The unit shall only transmit if an MMSI has been programmed (see 6.5.1.1).

6.5 AIS information

6.5.1 Information content

The information provided by the Class B“CS” AIS shall include:

6.5.1.1 Static

- Identification (MMSI)
- Name of ship
- Type of ship
- Vendor ID (optional)
- Call sign
- Dimensions of ship and reference for position

The default value for type of ship shall be 37 (pleasure craft). Defaults for other static data shall be chosen such that it is obvious that the equipment has been properly initialised, in particular, the default MMSI shall be set to 000000000 and the equipment shall be designed such that transmissions are inhibited with this default setting (see 6.7.2).

6.5.1.2 Dynamic

- Ship's position with accuracy indication and integrity status
- Time in UTC ⁴
- Course over ground (COG)
- Speed over ground (SOG)
- True heading (optional)

6.5.1.3 Configuration information

The following information about configuration and options active in the specific unit shall be provided:

- AIS Class B“CS” unit;
- availability of minimum keyboard/display facility;

⁴ Date to be established by receiving equipment.

- availability of DSC channel 70 receiver;
- ability to operate in the whole marine band or the upper 525 kHz part of the band (see 6.2);
- ability to process channel management Message 22.

6.5.1.4 Short safety-related messages

Short safety-related messages, if used, shall be in compliance with ITU-R M.1371-1 and shall use pre-configured contents.

It shall not be possible for the user to alter the pre-configured contents.

6.5.2 Information reporting intervals

The Class B“CS” AIS shall transmit position reports (Message 18) in reporting intervals of

- 30 s if SOG > 2 kn;
- 3 min if SOG ≤ 2 kn

provided that transmission time periods are available. A command received by Message 23 shall override the reporting interval; a reporting interval of less than 5 s is not required.

Static Data submessages 24A and 24B shall be transmitted every 6 min in addition to and independent of the position report (see 7.4.1). Message 24B shall be transmitted within 1 min following Message 24A.

6.5.3 Permissible initialisation period

The AIS shall start transmitting position reports within

- cold start: 30 min;
- warm start (if off for less than 1 h): 5 min;
- short signal loss (GNSS signal lost for less than 5 min): resume within a time of twice the reporting interval.

6.6 Alarms and indications, fall-back arrangements

6.6.1 Integrity and protection

The Class B“CS” AIS shall be equipped with built in integrity tests (BIIT). The BIIT shall run continuously or at appropriate intervals simultaneously with the standard functions of the equipment.

If any failure or malfunction is detected that will significantly reduce integrity or stop operation of the Class B“CS” AIS, a visual indication shall be given (for example a LED, see 6.7.1). This includes the detection of background noise above –77 dBm (see 7.3.1.3).

The Class B“CS” AIS installation, when operating, shall not be damaged by the effects of open-circuited or short-circuited antenna terminals.

6.6.2 Transmitter shutdown procedure

An automatic transmitter shutdown shall be provided in the case where a transmitter does not discontinue its transmission within 1 s of the end of its nominal transmission. This procedure shall be independent of the operating software.

6.6.3 Position sensor fallback conditions

Priorities and affected position report data (refer to ITU-R M.1371-1 A2/3.3.8.2.1) shall be as follows:

Table 1 – Position sensor fallback conditions

Priority	Position sensor status		Affected data in Message 18			
			Position accuracy flag	Time stamp	RAIM-flag	Position Longitude/Latitude
1.	External DGNSS in use (corrected) ^a		1 *	UTC-sec	1/0 *	Lat/Lon (external)
2.	Internal DGNSS in use (corrected; Message 17)		1 *	UTC-sec	1/0 *	Lat/Lon (internal)
3.	Internal DGNSS in use (corrected; e.g. beacon) ^c		1 *	UTC-sec	1/0 *	Lat/Lon (internal)
4.	External GNSS in use (uncorrected) ^a		0 *	UTC-sec	1/0 *	Lat/Lon (external)
5.	Internal GNSS in use (uncorrected) ^b		0 *	UTC-sec	1/0 *	Lat/Lon (internal)
6.	No sensor position in use	Manual position input	N/A	61	N/A	Do not transmit
		Dead reckoning position		62		Do not transmit
		No position		63		Do not transmit
<p>* If RAIM available "1"; if not, default "0".</p> <p>^a Applicable only if an input from an external GNSS receiver is provided (see 6.3) which may only be used if the conditions specified in 6.3 are fulfilled.</p> <p>^b Applicable in all configurations (minimum requirement).</p> <p>^c Applicable only if (optionally) an internal beacon receiver is provided.</p>						

If RAIM is available (indicated by a valid GBS sentence or equivalent information), the position accuracy flag shall be evaluated using following table:

Table 2 – Use of accuracy (PA) flag

		PA flag	RAIM flag
Uncorrected	No RAIM, GBS invalid	0	0
	GBS valid, expected error <5 m	1	1
	GBS valid, expected error >5 m	0	1
Corrected	No RAIM, GBS invalid	0	0
	GBS valid, expected error <15 m	1	1
	GBS valid, expected error >15 m	0	1

If the GNSS sensor is inoperative, the unit shall not transmit scheduled Messages 18 and 24 unless interrogated by a Base Station⁵.

⁵ Note that in this case, the synchronisation process will not take into account distance delays.

The Class B“CS” AIS shall automatically select the position source with the highest priority available. If data availability changes, the Class B“CS” AIS shall maintain the position source for the next scheduled position report and automatically switch to the position source with the highest priority available afterwards. During this period, the latest valid position shall be used for reporting.

6.6.4 SOG/COG sensor fallback conditions

SOG/COG information shall be of the same source as position and follow the same fallback rules. This is to avoid transmission of information referenced to different points on the ship.

6.7 User interface

6.7.1 Indicators and display

The Class B“CS” AIS shall be provided with the following indicators:

- Power: power on and fully operable (transmitting and receiving properly);
- Tx timeout: if the unit has not transmitted a position report during the last two reporting intervals (nominal reporting interval can not be maintained for operational reasons, for example Message 23 quiet period, high VDL load);
- Error: detection of an error as a result of the BIIT (see 6.6.1).

If a display for received messages is provided, it shall:

- display received Messages 12 and 14;
- not display messages addressed to other stations.

6.7.2 Static data input

Means shall be provided to input and verify the static data prior to use. It shall not be possible for the user to alter the MMSI once programmed.

6.7.3 External interfaces

To enable a user to access, select and display the information on a separate system, the Class B“CS” AIS may be provided with an interface. If implemented, the formats and protocol for this data stream should be as defined by the IEC 61162 series and as a minimum, the VDM sentence should be supported. If provided, this interface shall not output information addressed to other stations.

The Class B“CS” AIS may be provided with an interface to input sensor data. If provided, an input interface for position sensor data shall be compliant with the IEC 61162 series.

7 Technical requirements

7.1 General

This clause covers layers 1 to 4 (Physical Layer, Link Layer, Network Layer, Transport Layer) of the Open System Interconnection (OSI) model.

Figure 1 illustrates the layer model of a Class B“CS” AIS station (Physical Layer to Transport Layer) and the layers of the applications (Session Layer to Application Layer):

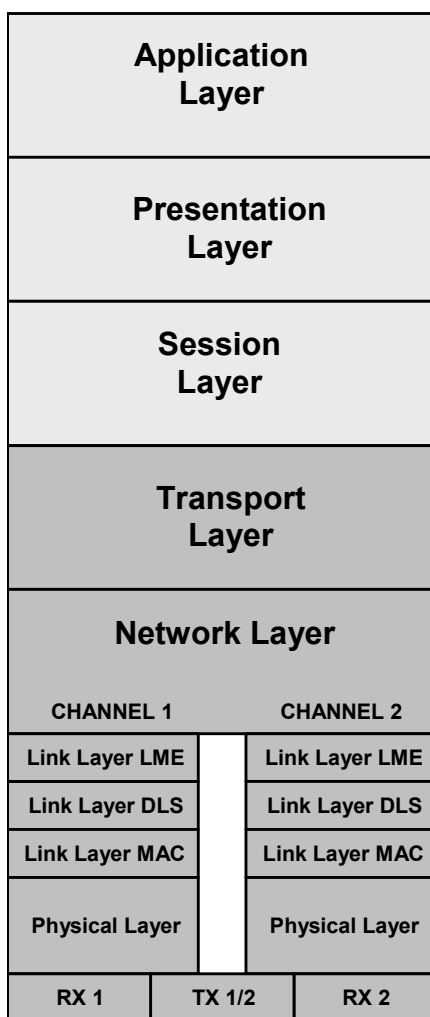

IEC 257/06

Figure 1 – OSI layer model

7.2 Physical layer

The Physical Layer is responsible for the transfer of a bit-stream from an originator to the data link.

7.2.1 Transceiver characteristics

General transceiver characteristics shall be as specified in Table 3.

Table 3 – Transceiver characteristics

Symbol	Parameter name	Value	Tolerance
PH.RFR	Regional frequencies (range of frequencies within RR Appendix 18) ^a (MHz) Full range 156,025 to 162,025 is also allowed. This capability will be reflected in Message 18.	161,500 to 162,025	-
PH.CHS	Channel spacing (encoded according to RR Appendix 18 with footnotes) ^a (kHz)	25	-
PH.CHB	Channel bandwidth (kHz)	Wide 25	
PH.AIS1	AIS 1 (default channel 1) (2087) ^a (MHz)	161,975	$\pm 3 \times 10^{-6}$
PH.AIS2	AIS 2 (default channel 2) (2088) ^a (MHz)	162,025	$\pm 3 \times 10^{-6}$
PH.BR	Bit rate (bit/s)	9 600	$\pm 50 \times 10^{-6}$
PH.TS	Training sequence (bits)	24	-
PH.TXTB	GMSK transmitter BT-product	0,4	
PH.RXBT	GMSK receiver BT-product	0,5	
PH.MI	GMSK modulation index	0,5	

^a See Recommendation ITU-R M.1084, Annex 4.

7.2.1.1 Dual channel operation

The AIS shall be capable of operating on two parallel channels in accordance with 7.4.1. Two separate TDMA receive channels or processes shall be used to simultaneously receive information on two independent frequency channels. One TDMA transmitter shall be used to alternate TDMA transmissions on two independent frequency channels.

Data transmissions shall default to AIS 1 and AIS 2 unless otherwise specified by a competent authority, as described in 7.4.1 and Annex C.

7.2.1.2 Bandwidth

The class B^{CS} AIS shall operate on 25 kHz channels according to ITU-R Recommendation M.1084-4 and Appendix 18 of the Radio Regulations.

7.2.1.3 Modulation scheme

The modulation scheme is bandwidth adapted frequency modulated Gaussian filtered minimum shift keying (GMSK/FM). The NRZI encoded data shall be GMSK coded before frequency modulating the transmitter.

7.2.1.4 Training sequence

Data transmission shall begin with a 24-bit demodulator training sequence (preamble) consisting of one segment synchronisation. This segment shall consist of alternating zeros and ones (0101...). This sequence shall always start with a 0.

7.2.1.5 Data encoding

The NRZI waveform is used for data encoding. The waveform is specified as giving a change in the level when a zero (0) is encountered in the bit stream.

Forward error correction, interleaving or bit scrambling is not used.

7.2.1.6 DSC operation

The Class B"CS" AIS shall be capable of receiving DSC channel management commands. It shall either have a dedicated receive process, or it shall be capable of retuning its TDMA receivers to channel 70 on a time sharing basis, with each TDMA receiver taking alternate turns to monitor channel 70 (for details see Annex C).⁶

7.2.2 Transmitter requirements

7.2.2.1 Transmitter parameters

Transmitter parameters shall be as given in Table 4.

Table 4 – Transmitter parameters

Transmitter parameters	Required results	Condition
Frequency error	±500 Hz normal ±1000 Hz extreme	
Carrier power (P _{SS})	33 dBm ±1,5 dB normal ±3 dB extreme	Conducted
Modulation spectrum	-25 dBW -60 dBW	Δfc < ±10 kHz ±25 kHz<Δfc< ±62,5 kHz
Modulation accuracy	<3400 Hz normal and extreme 2400 ± 480 Hz normal and extreme 2400 ± 240 Hz normal ±480 Hz extreme 1740 ± 175 Hz normal ±350 Hz extreme 2400 ± 240 Hz normal ±480 Hz extreme	Bit 0, 1 Bit 2, 3 Bit 4 ... 31 Bit 32 ... 199: For a bit pattern of 0101 For a bit pattern of 00001111
Power versus time characteristics	Transmission delay: 2083 μs Ramp up time: ≤313 μs Ramp down time: ≤313 μs Transmission duration: ≤23333 μs	Nominal 1 time period transmission
Spurious emissions	-36 dBm -30 dBm	9 kHz ... 1 GHz 1 GHz ... 4 GHz

7.2.3 Receiver requirements

Receiver parameters shall be as given in Table 5.

⁶ In some regions, the competent authority may not require DSC functionality.

Table 5 – Receiver parameters

Receiver parameters	Required results		
	Result in PER	Wanted signal	Unwanted signal(s)
Sensitivity	20 %	–107 dBm normal ^a –101 dBm extreme –104 dBm normal at ±500 Hz offset	
Error at high input levels	2 %	–77 dBm	
	10 %	–7 dBm	
Co-channel rejection	20 %	–101 dBm	–111 dBm –111 dBm normal at ±1 kHz offset
Adjacent channel selectivity	20 %	–101 dBm	–31 dBm normal
Spurious response rejection	20 %	–101 dBm	–31 dBm 50 MHz ... 520 MHz
Intermodulation response rejection	20 %	–101 dBm	–36 dBm
Blocking and desensitisation	20 %	–101 dBm	–23 dBm (<5 MHz) –15 dBm (>5 MHz)
Spurious emissions	–57 dBm	9 kHz ... 1 GHz	
	–47 dBm	1 GHz ... 4 GHz	

^a Normal and extreme test conditions as defined in 8.2.

7.3 Link layer

The Link layer specifies how data shall be packaged in order to apply error detection to the data transfer. The Link layer is divided into three sublayers.

7.3.1 Link sublayer 1: Medium Access Control (MAC)

The MAC sublayer provides a method for granting access to the data transfer medium, i.e. the VHF data link. The method used shall be Time Division Multiple Access (TDMA).

7.3.1.1 Synchronisation

Synchronisation shall be used to determine the nominal start of the CS time period (T_0).

7.3.1.1.1 Sync mode 1: AIS Stations other than Class B "CS" is received

If signals from other AIS stations complying with IEC 61993-2 or from Base Stations are received, the Class B "CS" shall synchronise its time-periods to their scheduled position reports (suitable account shall be taken of the propagation delays from the individual stations). This applies to Message types 1, 2, 3, 4, 18, 19 as far as they are providing position data and have not been repeated (repeat indicator = 0).

Synchronisation jitter shall not exceed ±3 bits (±312 µs) from the average of the received position reports. The average shall be calculated over a rolling 60 s period.

If these AIS stations are no longer received, the unit shall maintain synchronisation for a minimum of 30 s and then switch back to sync mode 2.

Other synchronisation sources fulfilling the same requirements are allowed (optionally) instead of the above.

7.3.1.1.2 Sync mode 2: no Station other than Class B"CS" is received

In the case of a population of Class B"CS" stations alone (in the absence of any other class of station that can be used as a synchronisation source) the Class B"CS" station shall determine the start of time-periods (T_0) according to its internal timing.

Time periods that are reserved by a Base Station using Message 20 shall be respected.

If the Class B"CS" unit receives an AIS station that can be used as a synchronisation source (being in sync mode 2) it shall evaluate timing and synchronise for its next transmission to this station.

7.3.1.2 Carrier-sense (CS) detection method

Within a time window of 1146 μs , starting at 833 μs and ending at 1979 μs after the start of the time period intended for transmission (T_0), the AIS Class B"CS" shall detect if that time period is used (CS detection window).

NOTE Signals within the first 8 bit (833 μs) of the time period are excluded from the decision (to allow for propagation delays and ramp down periods of other units).

The Class B"CS" AIS shall not transmit on any time period in which, during the CS detection window, a signal level greater than the "CS detection threshold" (7.3.1.3) is detected.

The transmission of a CSTDMA packet shall commence 20 bits ($T_A = 2083 \mu\text{s} + T_0$) after the nominal start of the time period (see Figure 2).

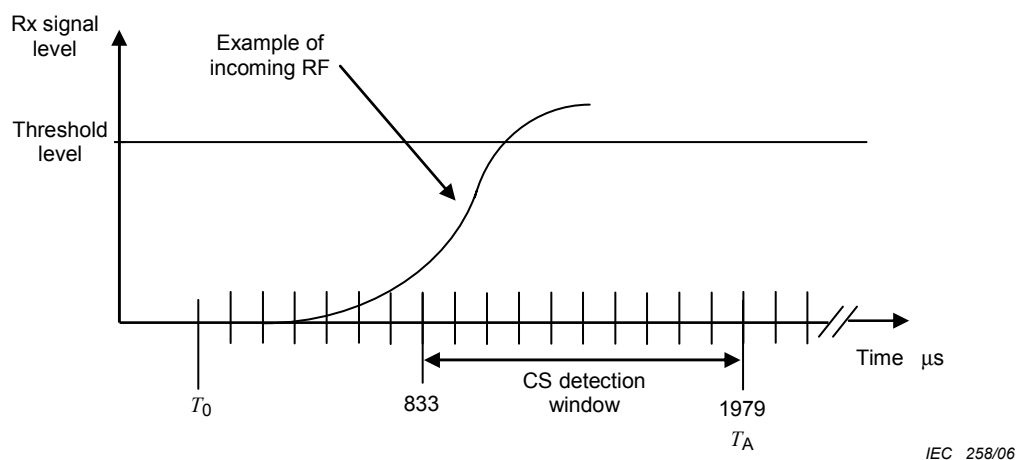

Figure 2 – Carrier-Sense timing

7.3.1.3 CS detection threshold

The CS detection threshold shall be determined over a rolling 60 s interval on each receive channel separately. The threshold shall be determined by measuring the minimum energy level (representing the background noise) plus an offset of 10 dB. The minimum CS detection threshold shall be -107 dBm and background noise shall be tracked for a range of at least 30 dB (-77 dBm).⁷

An indication shall be given if the background noise exceeds -77 dBm .

⁷ The following example is compliant with the requirement: Sample the RF signal strength at a rate $>1 \text{ kHz}$, average the samples over a sliding 20 ms period and over a 4 s interval determine the minimum period value. Maintain a history of 15 such intervals. The minimum of all 15 intervals is the background level. Add a fixed 10 dB offset to give the CS detection threshold.

7.3.1.4 VDL access

The transmitter shall begin transmission by turning on the RF power immediately after the duration of the Carrier-Sense window (T_A).

The transmitter shall be turned off after the last bit of the transmission packet has left the transmitting unit; nominal transmission end (T_E assuming no bit stuffing).

The access to the medium is performed as shown in Figure 3 and Table 6:

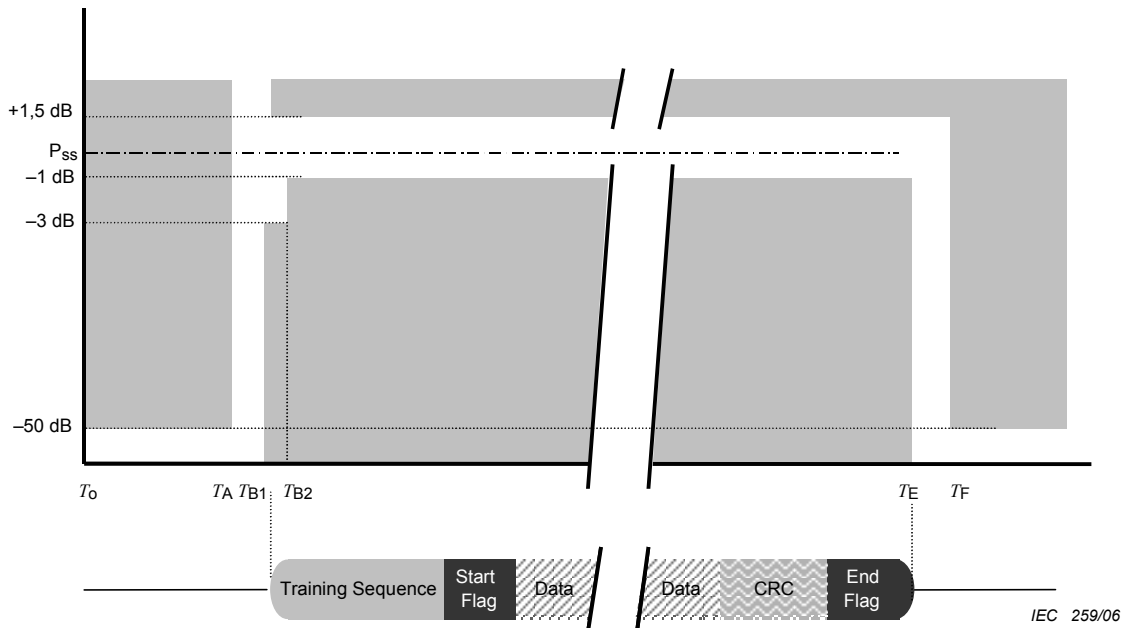

Figure 3 – Power versus time mask

Table 6 – Definition of timings for Figure 3

Reference	Bits	Time	Definition	
T_0	0	0 ms	Start of candidate transmission time period	
T_A	20	2,083 ms	Power shall not exceed -50 dB of P_{ss}	
T_B	T_{B1}	23	2,396 ms	Power shall reach within +1,5 dB or -3 dB of P_{ss}
	T_{B2}	25	2,604 ms	Power shall reach within +1,5 dB or -1 dB of P_{ss}
T_E (plus 1 stuffing bit)	248	25,833 ms	Power shall still remain within +1,5 dB or -1 dB of P_{ss}	
T_F (plus 1 stuffing bit)	251	26,146 ms	Power shall reach -50 dB of P_{ss} and stay below this	

There shall be no modulation of the RF after the termination of transmission (T_E) until the power has reached zero and next time division begins (T_G).

7.3.1.5 VDL State

The VDL State is based on the result of the carrier-sense detection (7.3.1.2) for a time period. A VDL time period can be in one of the following states:

- FREE: the time period is available and has not been identified as used in reference to 7.3.1.2.
- USED: the VDL has been identified as used in reference to 7.3.1.2.
- UNAVAILABLE: time periods shall be indicated as “UNAVAILABLE” if they are reserved by Base Stations using Message 20 regardless of their range.

Time-periods indicated as “UNAVAILABLE” shall not be considered as a candidate time-period for use by own station and may be used again after a timeout. The timeout shall be 3 min if not specified or as specified in Message 20.

7.3.2 Link sublayer 2: Data Link Service (DLS)

The DLS sublayer provides methods for

- data link activation and release;
- data transfer; or
- error detection and control.

7.3.2.1 Data link activation and release

Based on the MAC sublayer the DLS will listen, activate or release the data link. Activation and release shall be in accordance with 7.3.1.4.

7.3.2.2 Data transfer

Data transfer shall use a bit-oriented protocol which is based on the High-Level Data Link Control (HDLC) as specified by ISO/IEC 3309:1993. Information packets (I-Packets) shall be used with the exception that the control field is omitted (see Figure 4).

7.3.2.2.1 Bit stuffing

The bit stream shall be subject to bit stuffing. This means that if five consecutive ones (1's) are found in the output bit stream, a zero shall be inserted. This applies to all bits except the data bits of HDLC flags (Start flag and End flag, see Figure 4).

7.3.2.2.2 Packet format

Data is transferred using a transmission packet as shown in Figure 4:

Start-Buffer	Training sequence	Start flag	Data	FCS	End flag	End-Buffer
--------------	-------------------	------------	------	-----	----------	------------

IEC 260/06

Figure 4 – Transmission packet

The packet shall be sent from left to right. This structure is identical to the general HDLC structure, except for the training sequence. The training sequence shall be used in order to synchronise the VHF receiver as described in 7.2.1.4. The total length of the default packet is 256 bits. This is equivalent to 26,7 ms.

7.3.2.2.3 Start-Buffer

The Start-Buffer (refer to Table 7) is 23 bits long and consists of

- CS Delay 20 bits
 - Reception delay (sync jitter + distance delay)
 - Own synchronisation jitter (relative to synchronisation source)
 - Ramp up (received Message)
 - CS detection window
- Ramp up (own transmitter) 3 bits

Table 7 – Start-buffer

Seq.	Description	Bits	Note
1	Reception delay (synchronisation jitter + distance delay)	5	Class A: 3 bits of jitter (IEC 61993-2) + 2 bits (30 NM) distance delay; Base station: 1 bit of jitter (IEC 61993-2) + 4 bits (60 NM) distance delay
2	Own synchronisation jitter (relative to synchronisation source)	3	3 bits according to ITU-R M.1371
3	Ramp up (received Message)	8	Referring to IEC 61993-2, start of detection window (from a practical observation all observed transponders were fully ramped up after 6 bits)
4	Detection window	3	
5	Internal processing delay	1	
6	Ramp up (own transmitter)	3	
	Total	23	

7.3.2.2.4 Training sequence

The training sequence shall be a bit pattern consisting of alternating 0's and 1's (01010101...).

Twenty-four bits of preamble are transmitted prior to sending the flag. This bit pattern is modified due to the NRZI mode used by the communication circuit. See Figure 5.

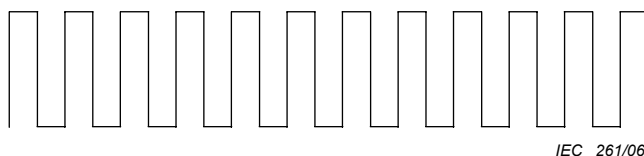

IEC 261/06

Figure 5a – Unmodified bit pattern

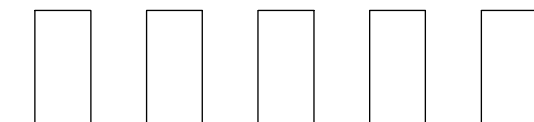

IEC 262/06

Figure 5b – Modified bit pattern by NRZI

Figure 5 – Training sequence

7.3.2.2.5 Start flag

The start flag shall be 8 bits long and consists of a standard HDLC flag. It is used to detect the start of a transmission packet. The Start flag consists of a bit pattern, 8 bits long: 01111110 (7Eh). The flag shall not be subject to bit stuffing, although it consists of 6 bits of consecutive ones (1's).

7.3.2.2.6 Data

The data portion in the default transmission packet transmitted in 1 time period is a maximum of 168 bits.

7.3.2.2.7 Frame Check Sequence (FCS)

The FCS uses the Cyclic Redundancy Check (CRC) 16-bit polynomial to calculate the checksum as defined in ISO/IEC 3309:1993. All the CRC bits shall be pre-set to one (1) at the beginning of a CRC calculation. Only the data portion shall be included in the CRC calculation (see Figure 6).

7.3.2.2.8 End flag

The End flag is identical to the Start flag as described in 7.3.2.2.5.

7.3.2.2.9 End-buffer

- bit stuffing 4 bits

NOTE The probability of 4 bits of bit stuffing is only 5 % greater than that of 3 bit; refer to ITU-R M.1371-1 A2 3.2.2.8.1.

- ramp down 3 bits
- distance delay 2 bits

NOTE A buffer value of 2 bits is reserved for a distance delay equivalent to 30 NM for own transmission.

A repeater delay is not applicable (Duplex Repeater Environment is not supported).

7.3.2.3 Summary of the transmission packet

The data packet is summarised as shown in Table 8.

Table 8 – Summary of the transmission packet

Action	Bits	Explanation
Start-buffer:		
CS-delay	20	T_0 to T_A in Figure 6
Ramp up	3	T_A to T_B in Figure 6
Training sequence	24	Necessary for synchronisation
Start flag	8	In accordance with HDLC (7Eh)
Data	168	Default
CRC	16	In accordance with HDLC
End flag	8	In accordance with HDLC (7Eh)
End-buffer:		
Bit stuffing	4	
Ramp down	3	
Distance delay	2	
Total	256	

7.3.2.4 Transmission timing

Table 9 and Figure 6 show the timing of the default transmission packet (one time division).

Table 9 – Transmission timing

$T(n)$	Time (μ s)	bit	Description
T_0	0	0	Start of time division; beginning of start buffer
T_A	2083	20	Start of transmission (RF power is applied)
T_B	2396	23	End of start buffer; RF power and frequency stabilisation time, beginning of training sequence
T_C	4896	47	Beginning of start flag
T_D	5729	55	Beginning of data
T_E	25729	247	Beginning of end buffer; nominal end of transmission (assuming 0 bit stuffing)
T_F	26042	250	Nominal end of ramp down (power reaches -50 dBc)
T_G	26667	256	End of time period, start of next time period

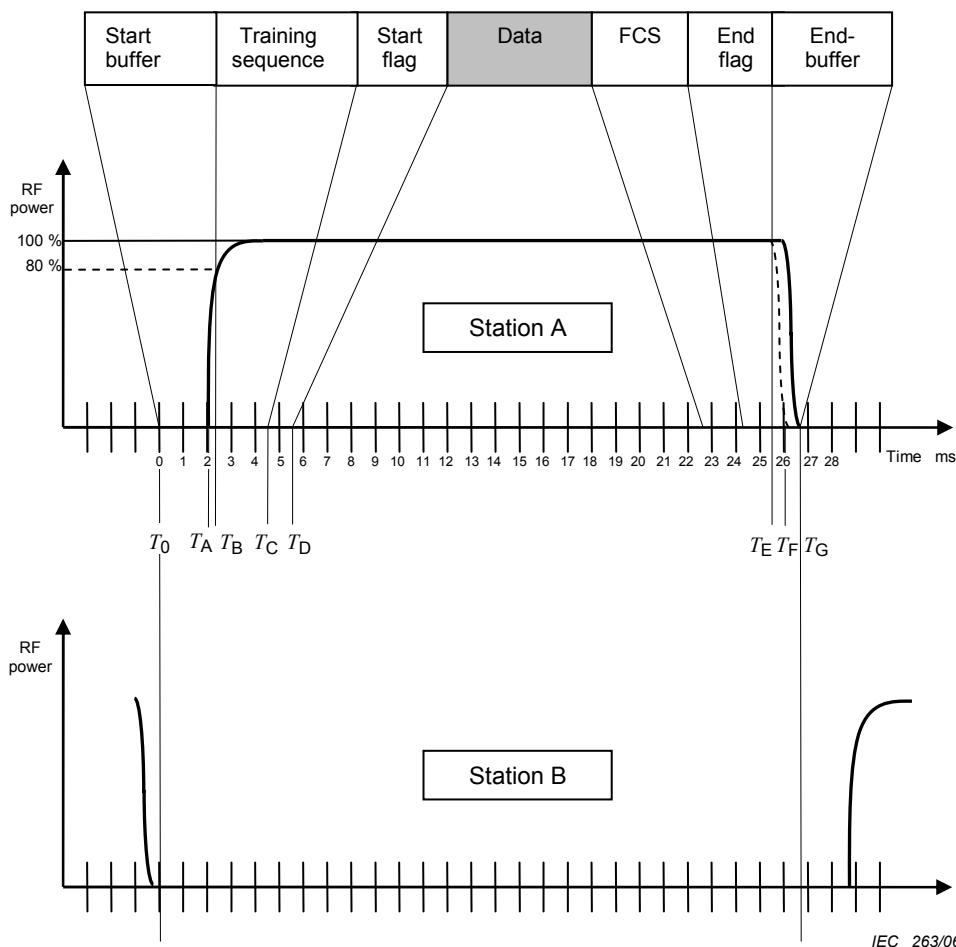

Figure 6 – Transmission timing

7.3.2.5 Long transmission packets

Autonomous transmissions are limited to one time period. When responding to an interrogation by a Base Station for Message 19, the response may occupy two time periods.

7.3.2.6 Error detection and control

Error detection and control shall be handled using the CRC polynomial as described in 7.3.2.2.7.

CRC errors shall result in no further action by the Class B“CS”.

7.3.3 Link sublayer 3 – Link Management Entity (LME)

The LME controls the operation of the DLS, MAC and the physical layer.

7.3.3.1 Access algorithm for scheduled transmissions

The Class B“CS” shall use a CSTDMA access using transmission periods, which are synchronised to periods of RF activity on the VDL.

The access algorithm is defined by the following parameters:

Table 10 – Access parameters

Term	Description	Value
Reporting Interval (RI)	Reporting interval as specified in 6.5.2	5 s ... 10 min
Nominal Transmission Time (NTT)	Nominal time-period for transmission defined by RI	
Transmission Interval (TI)	Time interval of possible transmission periods, centred around NTT	$TI = RI/3$ or 10 s whichever is less
Candidate Period (CP)	Time-period where a transmission attempt is made (excluding time periods indicated unavailable)	
Number of CP in TI		10

The CSTDMA algorithm shall follow the rules given below (refer to Figure 7):

- a) Randomly define 10 Candidate Periods (CP) in the Transmission Interval (TI)
- b) Starting with the first CP in TI, test for “Carrier-Sense” 7.3.1.2 and transmit if the status of CP is “unused”, otherwise wait for the next CP
- c) Transmission shall be abandoned if all 10 CPs are “used”

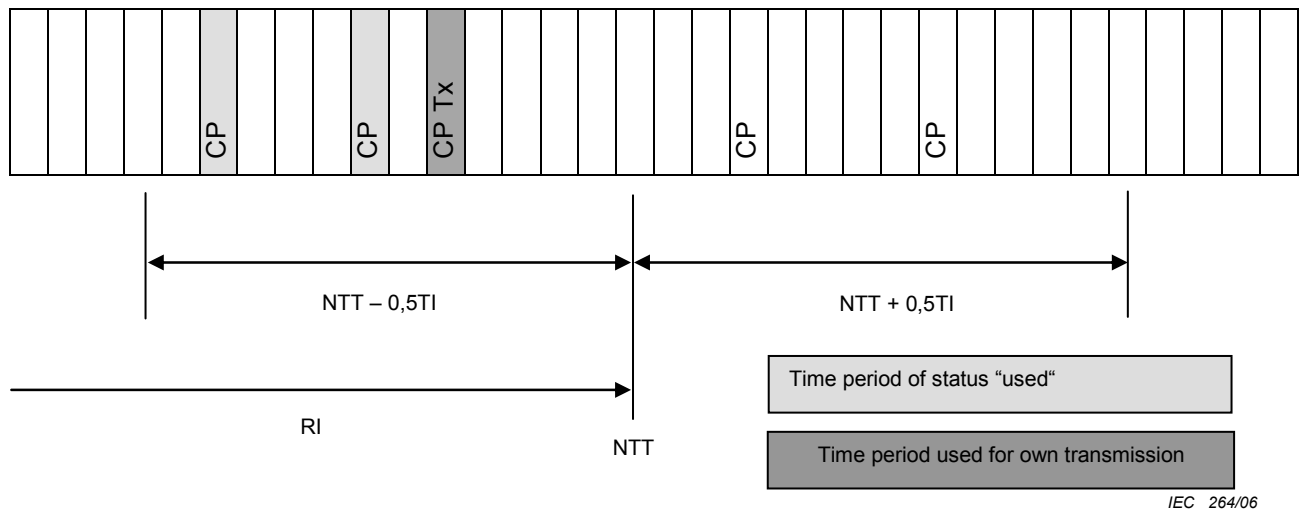

Figure 7 – Example for CSTDMA access

7.3.3.2 Access algorithm for unscheduled transmissions

Unscheduled transmissions, except responses to interrogations by a Base Station, shall be performed by assigning a Nominal Transmission Time within 25 s of the request and shall use the access algorithm described in 7.3.3.1.

If the option to process Message 12 is implemented, an acknowledgement Message 13 shall be transmitted in response to Message 12 on the same channel with up to 3 repetitions of the access algorithm if needed.

7.3.3.3 Modes of operation

There shall be three modes of operation:

- Autonomous (default mode)
- Assigned
- Interrogation

7.3.3.3.1 Autonomous

A station operating autonomously shall determine its own schedule for the transmission of its position reports.

7.3.3.3.2 Assigned

A station operating in the assigned mode shall use a transmission schedule assigned by a competent authority's Base Station. This mode is initiated by a group assignment command (Message 23, see 7.3.3.10).

The Assigned Mode shall affect only the transmission of position reports, and no other behaviour shall be affected. The transmission of position reports shall be as directed by Message 23.

If a station receives this group assignment command and belongs to the group addressed by region and selection parameters, it shall enter into assigned mode which shall be indicated by setting the 'Assigned Mode Flag' to "1".

To determine whether this group assignment command applies to the recipient station, it shall evaluate all selector fields concurrently.

When commanded to a specific transmission behaviour (Tx/Rx mode or reporting interval), the mobile station shall tag it with a time out, randomly selected between 4 min and 8 min after the first transmission⁸. After the time out has elapsed the station shall return to autonomous mode.

When commanded to a specific reporting rate, the AIS shall transmit the first position report with assigned rate after a time randomly selected between the time the Message 23 has been received and the assigned interval to avoid clustering.

Any individual assignment command received shall take precedence over any group assignment command received; i.e. the following cases shall be applied:

- if Message 22 is individually addressed, the Tx/Rx mode field setting of Message 22 shall take precedence over the Tx/Rx mode field setting of Message 23;
- if Message 22 with regional settings is received, the Tx/Rx mode field setting of Message 23 shall take precedence over the Tx/Rx mode field setting of Message 22. In the case of Tx/Rx mode field, the receiving station reverts to its previous Tx/Rx mode regional operating setting after the Message 23 assignment has expired.

When a Class B"CS" station receives a quiet time command, it shall continue to schedule nominal transmission time periods (NTT) but shall not transmit Messages 18 and 24 on either channel for the time commanded. Interrogations shall be answered during the quiet period. Transmissions of safety related messages may still be possible. After the quiet time has elapsed, transmissions shall be resumed using the transmission schedule as maintained during the quiet period.

Subsequent quiet time commands received during the first commanded quiet time shall be ignored.

The quiet time command shall override a reporting rate command.

⁸ Note that this can only be done by a Base Station. Note that because of the timeout, assignments may be reissued by the competent authority as needed. If a Message 23 commanding a reporting interval of 6 min or 10 min is not refreshed by the Base Station, the assigned station will resume normal operation after timeout and thus not establish the assigned rate.

7.3.3.3.3 Interrogation mode

A station shall automatically respond to interrogation messages (Message 15) from a ship or competent authority. Operation in the interrogation mode shall not conflict with operation in the other two modes. The response shall be transmitted on the channel where the Interrogation message was received.

If interrogated for Message 18 or 24 with no offset specified in Message 15, the response shall be transmitted within 30 s using the access algorithm as described in 7.3.3.2. If no free candidate period has been found, one transmission retry shall be performed after 30 s.

If interrogated with an offset given in Message 15, the response shall be transmitted in the specified time period without applying the access algorithm as described in 7.3.3.2.

An interrogation by a Base Station for Message 19 shall only be responded to if the interrogation Message 15 contains an offset to the time period in which the response shall be transmitted⁹.

Interrogations for the same message received before own response has been transmitted may be ignored.

7.3.3.4 Initialisation

At power on, a station shall monitor the TDMA channels for one minute to synchronise on received VDL transmissions (7.3.1.1) and to determine the CS detection threshold level (7.3.1.3). The first autonomous transmission shall always be the scheduled position report (Message 18) (see 6.5.3).

7.3.3.5 Communication State for CS access

Because Class B"CS" does not use any Communication State information, the corresponding field in Message 18 shall be filled with the following default value¹⁰:

1100000000000000110

and indicating the fixed value of "1" in the communication state selector flag.

7.3.3.6 VDL message use

The following Table 11 shows how the messages defined in M.1371/A2-3.2 shall be used by a Class B"CS" shipborne mobile AIS device. For further details refer to the appropriate section of M.1371.

⁹ The Base Station will reserve time periods by Message 20 prior to interrogation.

¹⁰ A Class B"CS" station by default reports sync state 3 and does not report "number of received stations" (reference to ITU-R M.1371-1 table 12). Therefore it will not be used as sync source for other stations.

Table 11 – Use of VDL messages by a Class B"CS" AIS

No.	Name of message	M.1371-1 Ref.	Receive and process ^a	Transmit by own station	Remark
0	Undefined				
1	Position Report (Scheduled)	A2-3.3.8.2.1	Opt	No	
2	Position Report (Assigned)	A2-3.3.8.2.1	Opt	No	
3	Position Report (When interrogated)	A2-3.3.8.2.1	Opt	No	
4	Base Station Report	A2-3.3.8.2.2	Opt	No	
5	Static and Voyage Related Data	A2-3.3.8.2.3	Opt	No	
6	Addressed Binary Message	A2-3.3.8.2.4	No	No	
7	Binary Acknowledge	A2-3.3.8.2.5	No	No	
8	Binary Broadcast Message	A2-3.3.8.2.6	Opt	No	
9	Standard SAR Aircraft Position Report	A2-3.3.8.2.7	Opt	No	
10	UTC and Date Inquiry	A2-3.3.8.2.8	No	No	
11	UTC/Date Response	A2-3.3.8.2.2	Opt	No	
12	Safety Related Addressed Message	A2-3.3.8.2.9	Opt	No	NOTE Information can also be transferred via Message 14
13	Safety Related Acknowledge	A2-3.3.8.2.5	No	Opt	Shall be transmitted if the option to process Message 12 is implemented
14	Safety Related Broadcast Message	A2-3.3.8.2.10	Opt	Opt	Transmit with predefined text only, see 7.3.3.7.
15	Interrogation	A2-3.3.8.2.11	Yes	No	Class B"CS" shall respond to interrogations for Message 18 and Message 24 It shall also respond to interrogations for Message 19 by a Base Station
16	Assigned Mode Command	A2-3.3.8.2.12	No	No	(Message 23 is applicable to the "CS" instead)
17	DGNSS Broadcast Binary Message	A2-3.3.8.2.13	Opt	No	
18	Standard Class B Equipment Position Report	A2-3.3.8.2.14	Opt	Yes	A Class B"CS" AIS shall indicate "1" for "CS" in flag bit 143
19	Extended Class B Equipment Position Report	A2-3.3.8.2.15	Opt	Yes	Transmit ONLY as response to Base Station interrogation
20	Data Link Management Message	A2-3.3.8.2.16	Yes	No	
21	Aids-to-Navigation Report	A2-3.3.8.2.17	Opt	No	
22	Channel Management Message	A2-3.3.8.2.18	Yes	No	Use of that function may be different in certain regions
23	Group Assignment		Yes	No	
24	Class B"CS" Static data		Opt	Yes	Part A and Part B
25 – 63	Undefined	None	No	No	Reserved for future use

^a "Receive and process" in this table means functionality visible for the user, for example output to an interface or display. For synchronisation, it is necessary to receive and internally process messages according to 7.3.1.1; this applies to Messages 1, 2, 3, 4, 18, 19.

7.3.3.7 Use of safety related message Message 14 (optional)

The data contents of Message 14 if implemented shall be predefined and the transmission shall not exceed one time period. Table 12 specifies the maximum number of data bits used for Message 14 and is based on the assumption that the theoretical maximum of stuffing bits will be needed.

Table 12 – Number of data bits for use with Message 14

Number of time periods	Maximum data bits	Stuffing bits	Total buffer bits
1	136	36	56

The Class B"CS" AIS shall only accept the initiation of a Message 14 once a minute by a user manual input. Automatic repetition is not allowed.

The Message 14 may have precedence over Message 18.

7.3.3.8 Message 18: Standard Class B"CS" equipment position report

The standard Class B equipment position report shall be output periodically and autonomously.

Table 13 – Contents of Message 18

Parameter	Number of bits	Description
Message ID	6	Identifier for Message 18; always 18
Repeat indicator	2	Used by the repeater to indicate how many times a message has been repeated. 0-3; shall be 0 for Class B"CS" transmissions
User ID	30	MMSI number
Reserved for regional or local applications	8	Reserved for definition by a competent regional or local authority. Shall be set to zero, if not used for any regional or local application.
SOG	10	Speed over ground in 1/10 kn steps (0-102,2 kn) 1 023 = not available, 1 022 = 102,2 kn or higher
Position accuracy	1	1 = high (<10 m) 0 = low (>10 m) shall be combined with RAIM information if available; see 6.6.3
Longitude	28	Longitude in 1/10 000 min (± 180 degrees, East = positive (as per 2's complement), West = negative (as per 2's complement). 181 degrees (6791AC0 hex) = not available = default)
Latitude	27	Latitude in 1/10 000 min (± 90 degrees, North = positive (as per 2's complement), South = negative (as per 2's complement), 91 degrees (3412140 hex) = not available = default)
COG	12	Course over ground in 1/10° (0-3 599). 3 600 (E10h) = not available = default; 3 601-4 095 shall not be used
True heading	9	Degrees (0-359) (511 indicates not available = default)
Time stamp	6	UTC second when the report was generated by the EPFS (0-59 60 if time stamp is not available, which shall also be the default value 61, 62, 63 are not used by the Class B"CS" AIS
Reserved for regional applications	2	Reserved for definition by a competent regional authority. Shall be set to zero, if not used for any regional application. Regional applications should not use zero
Class B unit flag	1	0 = Class B SOTDMA unit (shall not be used for the Class B"CS") 1 = Class B"CS" unit

Table 13 (continued)

Parameter	Number of bits	Description
Class B display flag	1	0 = No display available; not capable of displaying Messages 12 and 14 1 = Equipped with integrated display displaying Messages 12 and 14
Class B DSC flag	1	0 = not equipped with DSC function 1 = equipped with DSC function (dedicated or time-shared)
Class B band flag	1	0 = Capable of operating over the upper 525 kHz band of the marine band 1 = Capable of operating over the whole marine band (irrelevant if Class B Message 22 flag is 0)
Class B Message 22 flag	1	0 = No Frequency management via Message 22, operating on AIS 1, AIS 2 only 1 = Frequency management via Message 22
Mode Flag	1	0 = Station operating in autonomous mode =default 1 = Station operating in assigned mode
RAIM-flag	1	RAIM flag of electronic position fixing device; 0 = RAIM not in use = default; 1 = RAIM in use (valid data for expected position error)
Communication state selector flag	1	1 = ITDMA communication state follows
Communication state	19	ITDMA communication state; refer to 7.3.3.5
Total number of bits	168	Occupies one time period

7.3.3.9 Message 24: Class B“CS” static data report

This message shall be used by Class B“CS” shipborne mobile equipment. The message consists of two parts. Message 24B shall be transmitted within 1 min following Message 24A.

In case of an interrogation for Message 24, the response shall include Part A and Part B.

Table 14 – Message 24 Part A:

Parameter	Number of bits	Description
Message ID	6	Identifier for Message 24; always 24
Repeat indicator	2	Used by the repeater to indicate how many times a message has been repeated. 0 = default; 3 = do not repeat any more
User ID	30	MMSI number
Part number	2	Identifier for the message part number; always 0 for Part A
Name	120	Maximum 20 characters 6-bit ASCII, @@@@@@@@@@@@@@@@@@@@ = not available = default
Total number of bits	160	Occupies one time period

Table 15 – Message 24 Part B:

Parameter	Number of bits	Description
Message ID	6	Identifier for Message 24; always 24
Repeat indicator	2	Used by the repeater to indicate how many times a message has been repeated. 0 = default; 3 = do not repeat any more
User ID	30	MMSI number
Part number	2	Identifier for the message part number; always 1 for Part B
Type of ship and cargo type	8	0 = not available or no ship = default 1-99 = as defined in § 3.3.8.2.3.2 of ITU-R M.1371-1 100-199 = preserved, for regional use 200-255 = preserved, for future use
Vendor ID	42	Unique identification of the Unit by a Number as defined by the manufacturer (option; "@@@@@@@" = not available = default).
Call Sign	42	Call sign of the MMSI-registered vessel. 7 x 6 bit ASCII characters, "@@@@@@@" = not available = default.
Dimension of ship/reference for position	30	Dimensions of ship in meters and reference point for reported position (see ITU-R M.1371-1 Figure 17 and 3.3.8.2.3.3)
Spare	6	
Total number of bits	168	Occupies one time period

7.3.3.10 Message 23: Group Assignment Command

The Group Assignment Command is transmitted by a base station when operating as a controlling entity for Class B AIS Stations.

Table 16 – Contents of Message 23

Parameter	Number of bits	Description
Message ID	6	Identifier for Message 23; always 23
Repeat Indicator	2	Used by the repeater to indicate how many times a message has been repeated. 0 – 3; default = 0; 3 = do not repeat any more
Source ID	30	MMSI of assigning station
Spare	2	Spare. Shall be set to zero
Longitude 1	18	Longitude of area to which the group assignment applies; upper right corner (north-east); in 1/10 min (±180°, East=positive, West=negative)
Latitude 1	17	Latitude of area to which the group assignment applies; upper right corner (north-east); in 1/10 min (±90°, North=positive, South=negative)
Longitude 2	18	Longitude of area to which the group assignment applies; lower left corner (south-west); in 1/10 min (±180°, East=positive, West=negative).
Latitude 2	17	Latitude of area to which the group assignment applies; lower left corner (south-west); in 1/10 min (±90°, North=positive, South=negative)
Station type	4	0 = all types of mobiles (default); 1 = reserved for future use; 2 = all types of Class B mobile stations; 3 = SAR airborne mobile station; 4 = AtoN station; 5= Class B"CS" shipborne mobile station (IEC 62287 only); 6 = inland waterways; 7 to 9 = regional use; 10 to 15 = for future use

Table 16 (continued)

Parameter	Number of bits	Description
Type of ship and cargo type	8	0= all types (default) 1...99 see Table 19 of ITU-R M.1371-1 100...199 reserved for regional use 200...255 reserved for future use
Spare	22	Reserved for future use. Not used. Shall be set to zero
Tx/Rx mode	2	This parameter commands the respective stations to one of the following modes: 0 = TxA/TxB, RxA/RxB (default); 1 = TxA, RxA/RxB, 2 = TxB, RxA/RxB, 3 = reserved for future use
Reporting Interval	4	This parameter commands the respective stations to the reporting interval given in Table 17
Quiet Time	4	0 = default = no quiet time commanded; 1 – 15 = quiet time of 1 to 15 min
Spare	6	Spare. Not used. Shall be set to zero
Total	160	Occupies one time period

Table 17 – Reporting Interval Settings for use with Message 23

Reporting interval field setting	Reporting interval for Message18
0	As given by the autonomous mode
1	10 min
2	6 min
3	3 min
4	1 min
5	30 s
6	15 s
7	10 s
8	5 s
9	Next shorter reporting interval
10	Next longer reporting interval
11 – 15	Reserved for future use

NOTE When the dual channel operation is suspended by Tx/Rx mode command 1 or 2, the resulting reporting interval is twice the interval given in the above table.

7.4 Network layer

The network layer shall be used for

- establishing and maintaining channel connections;
- management of priority assignments of messages;
- distribution of transmission packets between channels;
- data link congestion resolution.

7.4.1 Dual channel operation

The normal default mode of operation shall be a two-channel operating mode, where the AIS simultaneously receives on both channel A and channel B in parallel.

The DSC process may use the receiving resources on a time-share basis as described in Annex C. Outside the DSC receiving periods, the two TDMA receiving processes shall work independently and simultaneously on channel A and channel B.

For periodic repeated messages, the transmissions shall alternate between channel A and channel B. The alternating process shall be independent for Message 18 and Message 24.

Transmission of complete Message 24 shall alternate between channels (all submessages to be transmitted on the same channel before alternating to the other channel).

Channel access is performed independently on each of the two parallel channels.

Responses to interrogations shall be transmitted on the same channel as the initial message.

For non-periodic messages other than those referenced above, the transmissions of each message, regardless of message type, shall alternate between channel A and channel B.

7.4.2 Channel management

Channel management shall be carried out according to ITU-R M.1371-1 A2/4.1 except:

- channel management commands shall only be accepted by Message 22 and DSC command;
- the Class B"CS" AIS is only required to operate in the band specified in 6.2 with a channel spacing of 25 kHz. It shall stop transmitting if commanded to a frequency outside its operating capability.

Table 18 – Channel management

		Step	Region 1 Channel A (frequency 1)	Region 1 Channel B (frequency 2)	Region 2 Channel A (frequency 3)	Region 2 Channel B (frequency 4)
Region 1		A	x	x		
	Transitional zone	B	xx		xx	
Region 2	Transitional zone	C	xx		xx	
		D			x	x
x	transmit with nominal reporting rate					
xx	transmit with doubled reporting rate					

When entering (step A to B) or leaving (step C to D) a transitional zone the Class B"CS" AIS shall continue to evaluate the CS threshold taking into account the noise level of the old channel initially and the new channel as time progresses. It shall continuously transmit (on frequency 1 and frequency 3 in step B) with the required rate maintaining its schedule.

7.4.3 Distribution of transmission packets

7.4.3.1 Assigned Reporting intervals

A competent authority may assign reporting intervals to any mobile station by transmitting group assignment Message 23. An assigned reporting interval shall have precedence over the nominal reporting rate; a reporting interval of less than 5 s is not required.

The Class B"CS" shall react to next shorter or next longer commands only once until time out.

7.4.4 Data link congestion resolution

The Class B"CS" AIS shall only transmit if it has verified that the time period intended for transmission does not interfere with transmissions made by stations complying with IEC 61993-2 and Base Stations. In case of high channel load the Class B"CS" AIS might not be able to transmit.

7.5 Transport layer

The transport layer shall be responsible for

- converting data into transmission packets of correct size;
- sequencing of data packets;
- interfacing protocol to upper layers (see 7.1).

7.5.1 Transmission packets

A transmission packet is an internal representation of some information, which can ultimately be communicated to external systems. The transmission packet is dimensioned so that it conforms to the rules of data transfer.

The transport layer shall convert data intended for transmission, into transmission packets.

The Class B"CS" AIS shall only transmit Messages 18, 19 and 24 (Table 11) and optionally transmit Message 14.

7.5.2 Sequencing of data packets

The Class B"CS" AIS is periodically transmitting the standard position report Message 18.

This periodic transmission shall use the access scheme described in 7.3.3.1. If a transmission attempt fails because of, for example high channel load, this transmission shall not be repeated. Additional sequencing is not necessary.

7.6 Digital Selective Calling (DSC)

Requirements for DSC are given in Annex C.

8 Test conditions

8.1 General

When a requirement in this standard is different from IEC 60945, the requirement in this standard shall take precedence.

8.2 Normal and extreme test conditions

8.2.1 Normal test conditions

8.2.1.1 Temperature and humidity

Temperature and humidity shall be within following range:

Temperature	+15 °C to +35 °C
Humidity	20 % to 75 %

8.2.1.2 Power supply

The normal power supply for the tests shall be the nominal voltage as defined by the manufacturer $\pm 3\%$.

8.2.2 Extreme test conditions

Test under extreme test conditions shall be a combination of high temperature (dry heat) and upper limit of supply voltage applied simultaneously and low temperature and lower limit of supply voltage applied simultaneously (see Clause 9).

During type-testing of battery operated equipment the power source to the equipment may be replaced by a test power source, capable of producing normal and extreme test voltages.

8.3 Test signals

NOTE Transmitters may have limitations concerning their maximum continuous transmit time and/or their transmission duty cycle. It is intended that such limitations are respected during testing.

8.3.1 Standard test signal number 1

A DSC modulated data signal comprising an infinite length of 01010101 (dotting pattern; refer to ITU-R Recommendation M.825).

8.3.2 Standard test signal number 2

A series of 010101 as the data within an AIS message frame, with header, start flag, end flag and CRC. NRZI is not applied to the 010101 bit stream or CRC (i.e. unaltered "On Air" data). The RF should be ramped up and down on either end of the AIS message frame.

8.3.3 Standard test signal number 3

A series of 00001111 as the data within an AIS message frame, with header, start flag, end flag and CRC. NRZI is not applied to the 00001111 bit stream or CRC. The RF should be ramped up and down on either end of the AIS message frame.

8.3.4 Standard test signal number 4

A Pseudo Random Sequence (PRS) as specified in ITU-T Recommendation O.153 as the data within an AIS message frame with header, start flag, end flag and CRC. NRZI is not applied to the PRS stream or CRC. The RF should be ramped up and down on either end of the AIS message frame.

8.3.5 Standard test signal number 5

This test signal consists of 200 packets grouped into clusters of 4 as described in Figure 8. Each cluster consists of 2 consecutive transmissions of the packets described in Table 19.

NRZI shall be applied to every packet. After sending packets 1 and 2 the notional initial state of the NRZI process shall be inverted and then packets 1 and 2 repeated.

Between every transmitted packet there shall be at least 2 free time periods. The RF carrier shall be switched off between packets to simulate normal operation.

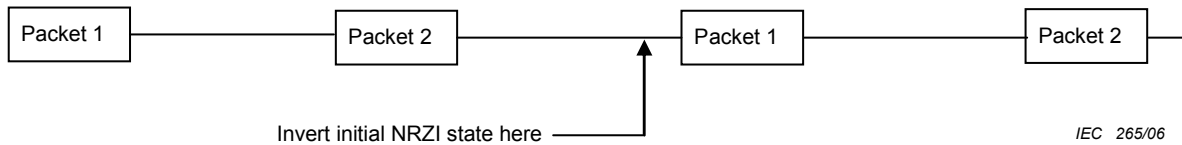

Figure 8 – Format for repeating four-packet cluster

Table 19 – Content of first two packets

Packet	Parameter	Bits	Contents	Comment
1	Training	22	0101....0101	Preamble reduced by 2 bits because of ramp-up overlap
	Start flag	8	01111110	
	Data	168	Pseudo Random	As per Table 20
	CRC	16	Calculated	
	End flag	8	01111110	
2	Training	22	1010....1010	Preamble reduced by 2 bits because of ramp-up overlap
	Start flag	8	01111110	
	Data	168	Pseudo Random	As per Table 20
	CRC	16	Calculated	
	End flag	8	01111110	

Table 20 – Fixed PRS data derived from ITU-T.O.153

Address	Contents (HEX)							
0-7	0x04	0xF6	0xD5	0x8E	0xFB	0x01	0x4C	0xC7
	0000.0100	1111.0110	1101.0101	1000.1110	1111.1011	0000.0001	0100.1100	1100.0111
8-15	0x76	0x1E	0xBC	0x5B	0xE5	0x92	0xA6	0x2F
	0111.0110	0001.1110	1011.1100	0101.1011	1110.0101	1001.0010	1010.0110	0010.1111
16-20	0x53	0xF9	0xD6	0xE7	0xE0	21 Byte's = 168 bits (+ 4 stuffed bits) , CRC = 0x3B85		
	0101.0011	1111.1001	1101.0110	1110.0111	1110.0000			

8.4 Test arrangements

8.4.1 Standard test environment

8.4.1.1 Test set up

The EUT is tested in an environment using test equipment to simulate and to log VDL messages. Standard environment consists of at least one simulated Class A AIS test target transmitting Message 1 with a reporting interval of 10 s according to IEC 61993. The signal input level at the RF input port of the EUT for any simulated target shall be $-60 \text{ dBm} \pm 5 \text{ dB}$. EUT is stationary (SOG < 2 kn). Operation is checked on channels in the maritime mobile band as applicable.

8.4.1.2 DSC functionality

DSC functionality where provided shall be disabled except for the DSC tests according to Annex C.

8.4.1.3 Position test input

An appropriate test input shall be provided for simulated position information in IEC 61162-1 format. The rules for an external position sensor as defined in 6.3 shall not apply to this test input.

8.4.1.4 Test signals applied to the receiver input

Sources of test signals for application to the receiver input shall be connected in such a way that the source impedance presented to the receiver input is 50 Ω irrespective of whether one or more signals using a combining network are applied to the receiver simultaneously.

The levels of the test signals at the receiver input terminals (RF socket) shall be expressed in terms of dBm.

8.4.1.5 Waiver for receivers

If the manufacturer declares that both TDMA receivers are identical, the test shall be limited to one receiver and the test for the second receiver shall be waived. The test report shall mention this.

8.4.1.6 Artificial antenna (dummy load)

Tests shall be carried out using an artificial antenna, which shall be a non-reactive non-radiating load of 50 Ω connected to the antenna connector.

NOTE Some of the methods of measurement described in this standard for the transmitters allow for two or more different test set ups in order to perform those measurements. The corresponding figures illustrate, therefore, one particular test set up, and are given as examples. In many of those figures, power attenuators (providing a non-reactive non-radiating load of 50 Ω to the antenna connector) have been shown. These attenuators are not "artificial antennas" as defined in this subclause. The method of measurement used shall be stated in the test report.

8.4.1.7 Facilities for access

The EUT shall be fitted with a port for the purpose of the tests to monitor transmitted and received messages following the protocol of IEC 61162. If standard external interfaces are available, these will be used for the tests. Where further access means are required to perform any specific test, these shall be provided by the manufacturer.

8.4.2 Modes of operation of the transmitter

For the purpose of the measurements according to this standard, there shall be a means to operate the transmitter unmodulated or, alternatively, the method of obtaining an unmodulated carrier or special types of modulation patterns may be decided by agreement between the manufacturer and the test laboratory. It shall be described in the test report. It may involve suitable temporary internal modifications of the equipment under test.

8.4.3 Measurement uncertainties

Maximum values of absolute measurement uncertainties shall be as follows:

RF frequency	$\pm 1 \times 10^{-7}$
RF power	$\pm 0,75$ dB
Adjacent channel power	± 5 dB
Conducted spurious emission of transmitter	± 4 dB
Conducted spurious emission of receiver	± 3 dB
Two-signal measurement	± 4 dB
Three-signal measurement	± 3 dB

- Radiated emission of transmitter ±6 dB
- Radiated emission of receiver ±6 dB
- Transmitter timing characteristics ±1 bit (104 µs)
- Transmitter transient frequency (frequency difference) ±250 Hz

For the test methods according to this standard, these uncertainty figures are valid to a confidence level of 95 %.

The interpretation of the results recorded in a test report for the measurements described in this standard shall be as follows:

- a) the measured value related to the corresponding limit shall be used to decide whether equipment meets the requirements of this standard;
- b) the actual measurement uncertainty of the test laboratory carrying out the measurements, for each particular measurement, shall be included in the test report;
- c) the values of the actual measurement uncertainty shall be, for each measurement, equal to or lower than the figures given in this subclause (absolute measurement uncertainties).

9 Power supply, environmental and EMC tests

9.1 Test summary

Tests shall be done in accordance with IEC 60945 as specified in Table 21.

Table 21 – Test summary

Test title	Clause/subclause of IEC 60945	Comment
NOTE Left-adjusted bold headings refer to headings in IEC 60945		
Inter-unit connection	4.2.4 (6.4)	Interfaces other than IEC 61162 are allowed; see 6.7.3 waiver *
Power supply	4.3	
Extreme power supply	4.3.1 (7.1)	Lower limit of extreme d.c. power supply shall be –20 % of nominal voltage Waiver *
Excessive conditions	4.3.2 (7.2)	Waiver *
Power supply short-term variation and power supply failure	4.3.3 (7.3, 7.4)	Waiver *
Undervoltage (brown out) test		See 9.4; waiver *
Durability and resistance to environmental conditions	4.4 (8)	
Dry heat	8.2.1	Reduce time to 5 h; waiver * Note that 8.2.2 is covered by Clause 11
Damp heat	8.3	Waiver *
Low temperature (portable)	Storage: 8.4.1 Functional: 8.4.2	Waiver *
Thermal shock (portable)		No
Drop (portable)		No
Vibration/shock		See 9.2

Table 21 (continued)

Test title	Clause/subclause of IEC 60945	Comment
NOTE Left-adjusted bold headings refer to headings in IEC 60945		
Rain and spray (exposed)	Do 8.8	Waiver *
Immersion		No
Solar radiation	Yes	Waiver *
Oil resistance	Yes	Waiver *
Corrosion	Yes	Waiver *
Interference	4.5	
Electromagnetic emission	9	
Immunity to electromagnetic environment	10	
Compass safe distance	4.7 (11.2) Do 11.2	Waiver *: manufacturer may take liability for the figures given for CSD
Safety precautions	4.8	
Protection against dangerous voltages	4.8.1 (12.1) Do 12.1	Waiver *
Electromagnetic radiofrequency radiation	4.8.2 (12.2)	
X-radiation	4.8.3 (12.4)	
* This test may be waived if the manufacturer is able to produce evidence that the requirement is fulfilled.		

9.2 Vibration/shock

9.2.1 Vibration

9.2.1.1 Method of measurement

The vibration test shall be done using sweep range and amplitude as defined in IEC 60945 at a sweep rate of 0,2 octaves per minute (which is about 40 min per sweep).

One sweep up (2 Hz to 100 Hz) shall be followed by a sweep down (100 Hz to 2 Hz) for each axis keeping the EUT operational throughout.

9.2.1.2 Results required

Verify that the EUT stays operational throughout the test; a successful performance check shall be carried out at the end of the test period.

9.2.2 Shock

9.2.2.1 Purpose

The test provides a method by which responses of components and equipment comparable with those likely to be experienced in practice in the operational environment can be produced in the test laboratory.

This test only applies to exposed equipment.

9.2.2.2 Method of measurement

The EUT shall be mounted in the normal operating orientation and shall be kept operational during the shocks. The EUT shall be mechanically connected to the shock machine by its normal means of attachment. The peak acceleration shall be 100 m/s², pulse shape shall be half sine and duration 25 ms.

The shock pulse shall be measured by an accelerometer placed at the EUT fixing point nearest to the centre of the table surface.

- a) Carry out a performance check.
- b) Apply three successive upward shocks with the EUT operative.
- c) Check for external indications of damage.
- d) Carry out a second performance check.

9.2.2.3 Results required

There shall be no external indications of damage and there shall be no detectable degradation in performance during the performance check.

9.3 Performance tests/checks

For the Performance test, repeat tests of 10.2.1.1, and 10.2.1.2.

For the Performance check, repeat tests of 10.2.1.1, and 10.2.1.2.

9.4 Undervoltage test (brown out)

9.4.1 Purpose

This test simulates the situation where the nominal supply voltage drops to below acceptable levels and then recovers over a medium time period. This is consistent with the performance of a flat or unhealthy battery when an engine is started.

9.4.2 Method of test

Operate the EUT at the nominal supply voltage as indicated by the manufacturer.

- a) Gradually reduce the supply voltage to 40 % of the nominal supply voltage over a time period of 30 s.
- b) Gradually increase the supply voltage back to 80 % of the nominal supply voltage over a time period of 30 s.

9.4.3 Required result

- a) The unit shall not enter into any undefined or undesirable state as verified by a performance check.
- b) The EUT shall recover and be fully operational as verified by a performance check.

10 Operational tests

10.1 General

10.1.1 Quality assurance

(see 4.1.2)

10.1.1.1 Method of measurement

By inspection of documentation

10.1.1.2 Required results

The requirements of 4.1.2 shall be met.

10.1.2 Safety of operation

(see 4.1.3)

10.1.2.1 Method of measurement

By inspection.

10.1.2.2 Required results

The requirements of 4.1.3 shall be met.

10.1.3 Additional features

(see 4.1.4)

10.1.3.1 Method of measurement

Operate the EUT in standard test environment. Repeat tests that might be affected by the additional feature.

10.1.3.2 Required results

The requirements of 4.1.4 shall be met.

10.2 Modes of operation

(see 4.1.5)

10.2.1 Autonomous mode

(see 4.1.5.1)

10.2.1.1 Transmit position reports

10.2.1.1.1 Method of measurement

Set up standard test environment. Record the VDL communication and check for messages transmitted by the EUT.

10.2.1.1.2 Required results

Confirm that the EUT transmits Messages 18 and 24 following the nominal schedule and alternates between channel A and channel B.

10.2.1.2 Receive Class A position reports

10.2.1.2.1 Method of measurement

Set up standard test environment.

- a) Switch on test targets, then start operation of the EUT.
- b) Start operation of the EUT, then switch on test targets.
- c) Transmit test targets using same time periods on channel A and channel B.

Check the VDL communication, test output, and where provided, display or external interface of the EUT.

10.2.1.2.2 Required results

Confirm that EUT receives continuously under conditions 10.2.1.2.1 a), b) and c) and, where provided, outputs the received messages on the external interface or display.

10.2.1.3 Receive Class B"CS" position reports

NOTE This test is only applicable if a display or display interface for the received messages is provided.

10.2.1.3.1 Method of measurement

Set up standard test environment. Simulate at least one additional Class B"CS" test target (bit stuffing shall not increase 4 bit).

Check the VDL communication, test output, and display or external interface of the EUT.

10.2.1.3.2 Required results

Confirm that EUT receives the Class B"CS" test target continuously and, where provided, outputs the received Messages 18 and 24 on the external interface.

10.2.1.4 Receive in adjacent time periods

10.2.1.4.1 Method of measurement

Set up standard test environment. Simulate additional targets so that the first 4 of each 5 time periods are used. The reporting rate may be increased for the purpose of this test.

Check the VDL communication, test output, and where provided, display or external interface of the EUT.

10.2.1.4.2 Required results

Confirm that EUT continuously receives messages in the time periods adjacent to own transmission period with an acceptable loss of 5 %.

10.2.1.5 Rx performance test

10.2.1.5.1 Method of measurement

Set up standard test environment. Simulate additional targets so that 9 of 10 time periods are used.

Check the VDL communication, test output, and where provided, display or external interface of the EUT.

10.2.1.5.2 Required results

Confirm that EUT continuously receives messages and, where provided, outputs the received messages on the external interface with a loss of not more than 5 %.

10.2.2 Assigned mode

(see 4.1.5.2)

10.2.2.1 Group assignment

10.2.2.1.1 Method of measurement

Set up standard test environment and operate EUT in autonomous mode. Transmit a group assignment command Message 23 to the EUT addressing stations by

region,
station type and
type of ship

and commanding for

Tx/Rx mode,
reporting rate,
quiet time.

Record transmitted messages.

10.2.2.1.2 Required results

Confirm that the EUT transmits position reports Message 18 according to the defined parameters and reverts to standard reporting rate after 4 min to 8 min.

Confirm that the operation of the EUT is not affected when not addressed.

10.2.2.2 Base station reservations

10.2.2.2.1 Method of measurement

Set up standard test environment and operate EUT in autonomous mode. Transmit a reservation Message 20 to the EUT specifying reserved time periods.

Record transmitted messages.

10.2.2.2.2 Required results

Confirm that the EUT transmits position reports Message 18 without using reserved time periods.

10.2.3 Polled mode/interrogation response

(see 4.1.5.3)

10.2.3.1 Interrogation for Messages 18 and 24

10.2.3.1.1 Method of measurement

Set up standard test environment and operate EUT in autonomous mode. Apply an interrogation message (Message 15; EUT as destination) to the VDL according to message table (ITU-R M.1371-1 table 13) for responses with Message 18, Message 24:

- a) with transmission offset = 0,
- b) with transmission offset = defined value,
- c) with a Message 23 “quiet time” command transmitted before the interrogation.

Record transmitted messages and frame structure.

10.2.3.1.2 Required results

Check that the EUT transmits the appropriate interrogation response message as requested after defined transmission offset. Confirm that the EUT transmits the response to the interrogation on the same channel as that received.

10.2.3.2 Interrogation for Message 19

10.2.3.2.1 Method of measurement

Set up standard test environment and operate EUT in autonomous mode. Apply an interrogation message (Message 15; EUT as destination) to the VDL according to message table (M.1371-1 Table 13) for responses with Message 19:

- a) with transmission offset = 0,
- b) with transmission offset = defined value.

Record transmitted messages and frame structure.

10.2.3.2.2 Required results

Check that

- a) the EUT does not respond,
- b) the EUT transmits the appropriate interrogation response message as requested after defined transmission offset.

Confirm that the EUT transmits the response on the same channel as that received and the data content is identical with that in Message 24.

10.3 Messages extending one time period

(see 4.1.5)

10.3.1 Method of measurement

Check the documentation for a possibility to initiate transmission of messages longer than one time period.

10.3.2 Required results

It shall not be possible for the user to initiate the transmission of messages longer than one time period.

10.4 Channel selection

(see 6.2)

10.4.1 Valid channels

10.4.1.1 Method of measurement

Set up standard test environment and operate EUT in autonomous mode. Switch the EUT to different channels within the operating band as specified in 6.2 by transmission of channel management message (Message 22) broadcast and addressed to EUT.

Record the VDL messages on the designated channels and check “band flag” and “Message 22 flag” in Message 18 (note that DSC command is covered in Annex C).

10.4.1.2 Required results

Confirm that the EUT switches to the required channel accordingly.

10.4.2 Invalid channels

10.4.2.1 Method of measurement

Set up standard test environment and operate EUT in autonomous mode. Check units capability on the “band flag” and “Message 22 flag” in Message 18. Switch the EUT to channels outside the operating band as specified in 6.2.

Record the VDL messages on the designated channels.

10.4.2.2 Required results

Confirm that the EUT does not switch to the respective channels and stops transmissions.

10.5 Internal GNSS receiver

(see 6.3)

Relevant tests according to IEC 61108-1 shall be performed with regard to

- position accuracy, static;
- position accuracy, dynamic;
- COG/SOG accuracy;
- position update;
- status indications (including RAIM, where fitted).

10.6 AIS information

(see 6.5)

10.6.1 Information content

(see 6.5.1)

10.6.1.1 Defaults

10.6.1.1.1 Method of measurement

Set up the standard test environment and reset the equipment to enable the manufacturers static data delivery defaults. Attempt to set the equipment to operate in autonomous mode.

10.6.1.1.2 Required results

Confirm that the default MMSI is set at 000000000 and that other static data defaults unambiguously identify that the equipment has been properly initialised. Confirm that the transmissions are inhibited and that an indication is given that transmissions are inhibited.

10.6.1.2 Required information

10.6.1.2.1 Method of measurement

Set up standard test environment and operate EUT in autonomous mode. Apply all static data to the EUT.

Record all messages on VDL and check the contents of position report Message 18 and static data report Messages 24 A and B.

10.6.1.2.2 Required results

Confirm that data transmitted by the EUT complies with static data and position sensor data.

10.6.1.3 External sensor information

(see 6.3, 6.6.3)

This test is applicable if an optional interface for external sensors is provided.

10.6.1.3.1 Method of measurement

Set up standard test environment and operate EUT in autonomous mode.

- a) Apply external position data with expected error <10 m (from GBS sentence) and within 26 m of internal position.
- b) Simulate unavailable/invalid external sensor data and missing/incorrect checksum.
- c) Apply a non-WGS-84 or unspecified (no DTM) position input.
- d) Apply a low accuracy position input with expected error >10 m or without RAIM information (no GBS).
- e) Apply position data with more than 26 m apart from internal position

Record all messages on VDL and check the contents of position report Message 18 for position and COG/SOG.

10.6.1.3.2 Required results

- a) Confirm that data transmitted by the EUT complies with external sensor inputs.
- b), c), d), e) Confirm that external data is not used.

Confirm that accuracy and RAIM flags are set accordingly; confirm that position and COG/SOG are of the same source.

10.6.2 Information update rates

(see 6.5.2)

10.6.2.1 Nominal reporting interval

10.6.2.1.1 Method of measurement

Set up standard test environment and operate EUT in autonomous mode.

- a) Start with own SOG of 1 kn; record all messages on VDL for 10 min and evaluate reporting rate for position report of EUT by calculating average transmission offset over test period.
- b) Increase speed to 10 kn.
- c) Reduce speed to 1 kn.

Record all messages on VDL and check transmission offset between two consecutive transmissions.

10.6.2.1.2 Required results

- a) Reporting interval shall be 3 min (± 10 s).
- b) Confirm that the reporting interval of 30 s (± 5 s) has been established after the next transmission in the old schedule at the latest. The average reporting interval calculated over at least 25 transmissions shall be 30 s (± 2 s).
- c) Confirm that the reporting rate is reduced after 3 min (speed reduction).

10.6.2.2 Assigned reporting interval

10.6.2.2.1 Method of measurement

Set up standard test environment and operate EUT in autonomous mode.

- a) Transmit an assigned mode command Message 23 to the EUT with designated reporting intervals of 5 s to 3 min according to Table 17.
- b) Transmit an assigned mode command Message 23 to the EUT with designated reporting interval of 10 min.
- c) Transmit Messages 23 with a refresh rate of 1 min with designated reporting intervals of 6 min and 10 min.
- d) Transmit Messages 23 designated reporting interval field settings of 11-15.
- e) Change course, speed. Record transmitted messages.

10.6.2.2.2 Required results

- a) Confirm that the EUT transmits position reports Message 18 according to the parameters defined by Message 23. The EUT shall revert to autonomous mode with nominal reporting interval after 4 min to 8 min.
- b) Confirm that the EUT reverts to autonomous mode with nominal reporting interval after 4 min to 8 min.
- c) Confirm that the EUT transmits position reports Message 18 according to the parameters defined by Message 23.
- d) Confirm that the EUT does not change its nominal behaviour.
- e) The reporting interval shall not be affected by course or speed.

10.6.2.3 Static data reporting interval

10.6.2.3.1 Method of measurement

Set up standard test environment and operate EUT in autonomous mode. Record the transmitted messages and check for static data (Message 24).

Repeat the test at an assigned reporting interval of 5 s.

10.6.2.3.2 Required results

Confirm that the EUT transmits submessages 24A and 24B every 6 min (24B following 24A within 1 min). Transmission shall alternate between channel A and channel B and be independent of the Message 18 reporting interval.

10.7 Initialisation period

(see 6.5.3)

10.7.1 Method of measurement

Set up standard test environment with SOG>2 kn.

- a) Switch on the EUT from cold (off-time minimum 1 h) with EUT operating in autonomous mode.
- b) Switch off the EUT for a period of time between 15 min to 60 min and switch on again.
- c) Make the GNSS sensor unavailable for a period of time between 1 min to 5 min.

Record transmitted messages.

10.7.2 Required results

Confirm that the EUT starts regular transmission of Message 18 including valid position:

- a) within 30 min after switch on;
- b) within 5 min;
- c) stops transmitting after the next transmission and resumes within 1 min after enabling the position source.

10.8 Alarms and indications, fall-back arrangements

(see 6.6)

10.8.1 Built in integrity test

(see 6.6.1)

10.8.1.1 Method of measurement

Check manufacturer's documentation on built-in integrity test.

10.8.1.2 Required result

Verify that an indication is provided if a malfunction is detected.

10.8.2 Transceiver protection

10.8.2.1 Method of measurement

Set up standard test environment and operate EUT in autonomous mode. Open-circuit and short-circuit VHF antenna terminals of the EUT for at least 5 min each.

10.8.2.2 Required results

The EUT shall be operative again within 2 min after refitting the antenna without damage to the transceiver.

10.8.3 Transmitter shutdown procedure

(see 6.6.2)

10.8.3.1 Method of measurement

Check manufacturer's documentation on transmitter shutdown procedure.

10.8.3.2 Required result

Verify that a transmitter shutdown procedure independent of the operating software is provided.

10.8.4 Position sensor fallback conditions

(see 6.6.3)

10.8.4.1 Method of measurement

Set up standard test environment and operate EUT in autonomous mode. Where an option for an external GNSS sensor is not provided, then the respective tests shall be omitted.

Apply position sensor data in a way that the EUT operates in the states defined below:

- a) external DGNSS in use if implemented;
- b) internal DGNSS in use (corrected by Message 17) if implemented;
- c) internal DGNSS in use (corrected by a beacon) if implemented;
- d) external GNSS in use if implemented;
- e) internal GNSS in use;
- f) no sensor position in use.

Check the position accuracy and RAIM flag in the VDL Message 18 and, where provided, the ALR sentence.

10.8.4.2 Required result

Verify that the use of position source, position accuracy flag, RAIM flag and position information complies with Table 1.

Verify that the position sensor status is maintained for the next scheduled report and changed after that.

10.8.5 Speed sensors

(see 6.6.4)

10.8.5.1 Method of measurement

Set up standard test environment and operate EUT in autonomous mode. Where an option for an external GNSS sensor is not provided, this test shall be omitted.

- a) Apply valid external DGNSS position and speed data.
- b) Make external DGNSS position invalid (for example by wrong checksum, "valid/invalid" flag) .

10.8.5.2 Required result

- a) Check that the external data for SOG/COG is transmitted in Message 18.
- b) Check that the internal data for SOG/COG is transmitted in Message 18.

10.9 User interface

(see 6.7)

10.9.1 Display

(see 6.7.1)

10.9.1.1 Method of measurement

Set up standard test environment and operate EUT in autonomous mode.

- a) Check status indications for power, Tx timeout, Error.
- b) Apply Message 23 “quiet time” of >7 min.
- c) Simulate VDL load in order to make it impossible for the EUT to find free candidate periods.

10.9.1.2 Required results

- a) Indicators shall be available and working correctly according to manufacturer’s documentation.
- b) Check that the Tx timeout indication is activated.
- c) Check that the Tx timeout indication is activated.

10.9.2 Message display

This test is only applicable if a message display is provided.

10.9.2.1 Method of measurement

Set up standard test environment and operate EUT in autonomous mode.

Transmit a Message 14.

10.9.2.2 Required results

Verify that the EUT displays the message.

10.9.3 Static data input

(see 6.7.2)

10.9.3.1 Method of measurement

Verify that static data can be input to the unit according to the manufacturer’s documentation. Set up standard test environment and operate EUT in autonomous mode.

10.9.3.2 Required results

Check that static data are transmitted correctly by the EUT and that the MMSI cannot be altered by the user.

10.9.4 External interfaces

(see 6.7.3)

10.9.4.1 Display interface

This test only applies if a display interface is provided.

10.9.4.1.1 Method of measurement

Set up standard test environment and operate EUT in autonomous mode. Apply a safety related broadcast Message 14 through the VDL to the EUT.

Check the output on the display interface.

10.9.4.1.2 Required results

The interface shall be compliant with IEC 61162 series protocol and the manufacturer's documentation of interface hardware.

11 Physical tests

11.1 TDMA transmitter

(see 7.2.2)

11.1.1 Frequency error

11.1.1.1 Definition

The frequency error of the transmitter is the difference between the measured carrier frequency in the absence of modulation of the transmitter and its required frequency.

11.1.1.2 Method of measurement

- The carrier frequency shall be measured in the absence of modulation.
- Tests shall be performed on the lowest operating frequency on which the EUT can transmit according to the manufacturer's specification and AIS 2 (162,025 MHz).
- The measurement shall be made under normal and extreme test conditions.

11.1.1.3 Required results

The frequency error shall not exceed $\pm 0,5$ kHz under normal and ± 1 kHz under extreme test conditions.

11.1.2 Carrier power

11.1.2.1 Definition

The power of a radio frequency signal (conducted) is defined as the mean power delivered to a 50Ω load during a radio frequency cycle. The Carrier Power is defined as the average radio frequency power measured over the transmitter duration. The transmitter duration is defined in 7.3.1.4.

11.1.2.2 Method of measurement

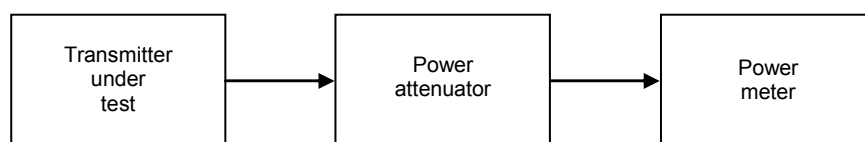

IEC 266/06

Figure 9 – Measurement arrangement for carrier power

- The transmitter shall generate test signal number 4.
- The average power shall be measured over the transmitter duration. This power shall be further averaged over measurements from 200 transmissions. This value shall be corrected according to the transmitter duty cycle to indicate the carrier power.
- Tests shall be performed on the lowest operating frequency on which the EUT can transmit according to the manufacturer's specification and AIS 2 (162,025 MHz).
- The measurement shall be carried out under normal and extreme test conditions.

11.1.2.3 Required results

At all test frequencies, the carrier power shall be 33 dBm ±1,5 dBm under normal test conditions.

At all test frequencies the carrier power shall be 33 dBm ±3 dBm under extreme test conditions.

11.1.3 Transmission spectrum

11.1.3.1 Definition

This test is to ensure that the modulation and transient sidebands produced by the transmitter under normal operating conditions fall within the allowable mask.

11.1.3.2 Method of measurement

- a) The test shall use test signal number 4.
- b) The EUT shall be connected to a spectrum analyser. A resolution bandwidth of 1 kHz, video bandwidth of 3 kHz or greater and positive peak detection (maximum hold) shall be used for this measurement. A sufficient number of sweeps shall be used and sufficient transmission packets measured to ensure that the emission profile is developed.
- c) Tests shall be performed on the lowest operating frequency on which the EUT can transmit according to the manufacturer's specification and AIS 2 (162,025 MHz).

11.1.3.3 Required result

The spectrum for slotted transmission shall be within the emission mask as follows:

- in the region between the carrier and ±10 kHz removed from the carrier, the modulation and transient sidebands shall be below 0 dBc;
- at ±10 kHz removed from the carrier, the modulation and transient sidebands shall be below –25 dBc;
- at ±25 kHz to ±62,5 kHz removed from the carrier, the modulation and transient sidebands shall be below the lower value of –60 dBc or –30 dBm;
- in the region between ±10 kHz and ±25 kHz removed from the carrier, the modulation and transient sidebands shall be below a line specified between these two points.

The reference level for the measurement shall be the carrier power (conducted) recorded for the appropriate test frequency in 11.1.2.

For information the emission mask specified above is shown in Figure 10.

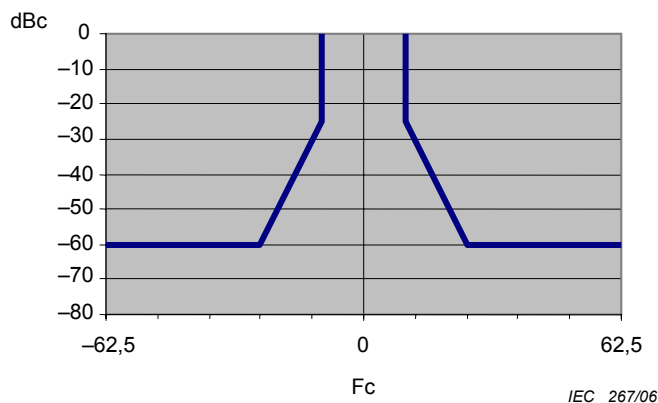

Figure 10 – Emission mask

11.1.4 Modulation accuracy

11.1.4.1 Definition

The modulation accuracy is the measurement of the peak frequency deviation of the transmitter modulation and the correct implementation of the GMSK BT filtering.

11.1.4.2 Method of measurement

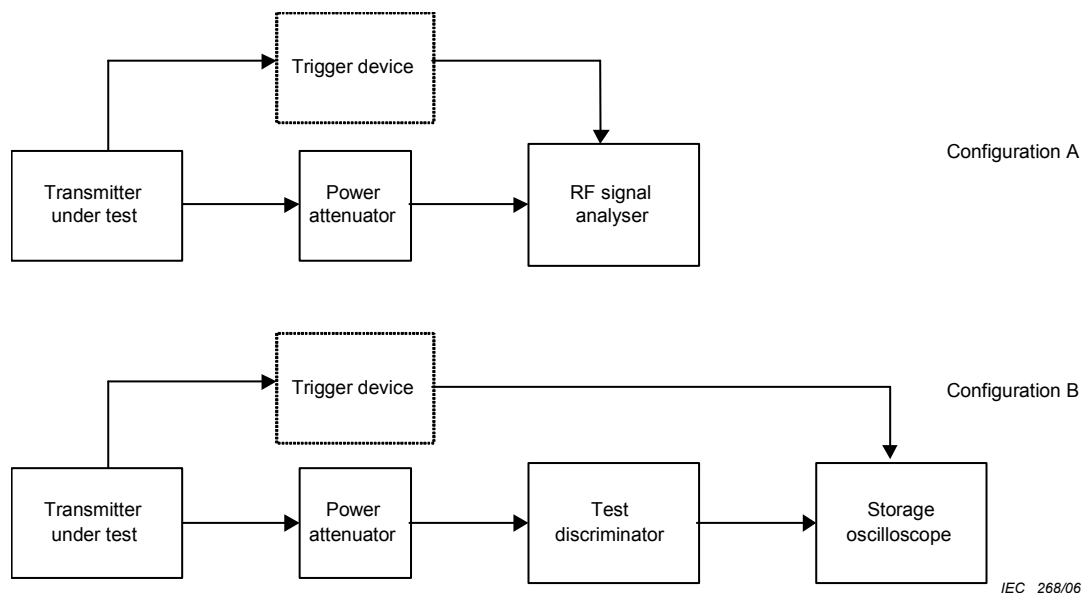

Figure 11 – Measurement arrangement for modulation accuracy

The measurement procedure shall be as follows:

- a) the equipment shall be connected in either configuration A or configuration B as shown. The trigger device is optional if the equipment is capable of synchronising to the transmitted bursts;
- b) the transmitter shall be tuned to AIS 2 (162,025 MHz);
- c) the transmitter shall be modulated with test signal number 2;
- d) the deviation from the carrier frequency shall be measured as a function of time;
- e) the transmitter shall be modulated with test signal number 3;
- f) the deviation from the carrier frequency shall be measured as a function of time;
- g) measurements shall be repeated at the lowest frequency on which the EUT can transmit, according to the manufacturer's specification;
- h) testing shall be repeated under extreme test conditions.

11.1.4.3 Required results

Peak frequency deviation at various points within the data frame shall comply with Table 22. These limits apply to both the positive and negative modulation peaks. Bit 0 is defined as the first bit of the training sequence.

Table 22 – Peak frequency deviation versus time

Measurement period from centre to centre of each bit	Test signal 2		Test signal 3	
	Normal	Extreme	Normal	Extreme
Bit 0 to bit 1	<3 400 Hz			
Bit 2 to bit 3	2 400 ±480 Hz			
Bit 4 to bit 31	2 400 ±240 Hz	2 400 ±480 Hz	2 400 ±240 Hz	2 400 ±480 Hz
Bit 32 to bit 199	1 740 ±175 Hz	1 740 ±350 Hz	2 400 ±240 Hz	2 400 ±480 Hz

11.1.5 Transmitter output power versus time function

11.1.5.1 Definition

Transmitter output power versus time function is a combination of the transmitter delay, attack time, release time and transmission duration (referring to Figure 3), where:

- a) transmitter delay (T_A) is the time between the start of the candidate transmission time period and the time when the transmission power exceeds –50 dBc;
- b) transmitter attack time ($T_B - T_A$) is the time between the transmit power exceeding –50 dBc and the moment when the transmit power has reached a level 1 dB below the measured steady-state power (P_{ss}) and maintains a level within +1,5/–1 dB from P_{ss} thereafter;
- c) transmitter release time ($T_F - T_E$) is the time between the end flag being transmitted and the moment when the transmitter output power has reduced to a level 50 dB below P_{ss} and remains below this level thereafter;
- d) transmission duration ($T_F - T_A$) is the time from when power exceeds –50 dBc to when the power returns to and stays below –50 dBc.

11.1.5.2 Method of measurement

- a) The measurement shall be carried out by transmitting test signal number 2 (note that this test signal generates one additional stuffing bit within its CRC portion).
- b) The EUT shall be connected to a spectrum analyser. A resolution bandwidth of 1 MHz, video bandwidth of 1 MHz and a sample detector shall be used for this measurement. The analyser shall be in zero-span mode for this measurement.
- c) For the purposes of this test, the EUT shall be equipped with a test signal (SYNC) indicating the start of each time period that it intends to transmit into. This will be used as a trigger source for the spectrum analyser. The SYNC signal shall be aligned to the nominal start time (T_0) of the transmission time period.
- d) Tests shall be performed on the lowest operating frequency on which the EUT can transmit according to the manufacturer’s specification and AIS 2 (162,025 MHz).

11.1.5.3 Required result

The transmitter power shall remain within the mask shown in Figure 3 and associated timings given in Table 6.

11.2 TDMA receivers

(see 7.2.3)

11.2.1 Sensitivity

11.2.1.1 Definition

The maximum usable sensitivity is the minimum level of signal (dBm) at the receiver input, produced by a carrier at the nominal frequency of the receiver, modulated with the typical test signal (test signal 5), which will, without interference, produce after demodulation a data signal with a specified packet error rate (*PER*).

11.2.1.2 Method of measurement

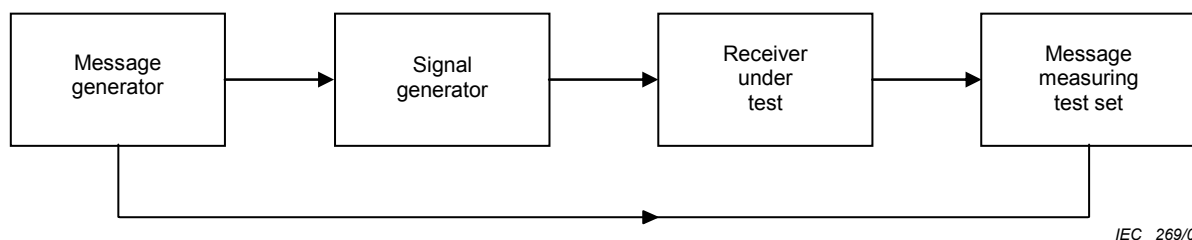

Figure 12 – Measurement arrangement

The measurement procedure shall be as follows:

- a) the signal generator shall be at the nominal frequency of the receiver and shall be modulated to generate test signal number 5;
- b) the signal level at the input of the receiver shall be set to -107 dBm;
- c) the message measuring test set shall be monitored and the packet error rate observed; The *PER* shall be derived by the following formula:

$$PER = (P_{TX} - P_{RX})/P_{TX} \times 100 (\%)$$

where

P_{RX} is the number of packets received without errors;

P_{TX} is the number of transmitted packets.

- d) the test shall be repeated at the nominal carrier frequency ± 500 Hz and the level at the input to the receiver adjusted to -104 dBm under normal conditions;
- e) the test shall be carried out on the lowest TDMA frequency declared by the manufacturer and AIS 2 (162,025 MHz);
- f) repeat under extreme conditions, at the nominal carrier frequency only. The signal generator shall be adjusted so the level at the input to the receiver is -101 dBm.

11.2.1.3 Required results

The *PER* shall not exceed 20 %.

11.2.2 Error behaviour at high input levels

11.2.2.1 Definition

The error behaviour (performance) at high input levels (noise free operation) is defined in the same manner as for the measurement of the maximum usable sensitivity when the level of the wanted signal is significantly above the maximum wanted sensitivity.

11.2.2.2 Method of measurement

The measurement configuration for receiver sensitivity (11.2.1) shall be used.

The signal generator shall be at the nominal frequency of the receiver and shall be modulated to generate test signal number 5. The test shall be carried out on the lowest TDMA frequency declared by the manufacturer and AIS 2 (162,025 MHz). The message measuring test set shall be monitored and the packet error rate observed.

- a) The level of the input signal shall be adjusted to a level of -77 dBm;
- b) The level of the input signal shall be adjusted to a level of -7 dBm.

11.2.2.3 Required results

The *PER* shall not exceed 2 % under a) and 10 % under b).

11.2.3 Co-channel rejection

11.2.3.1 Definition

The co-channel rejection is a measure of the capability of the receiver to receive a wanted modulated signal without exceeding a given degradation due to the presence of an unwanted modulated signal, both signals being at the nominal frequency of the receiver.

11.2.3.2 Method of measurement

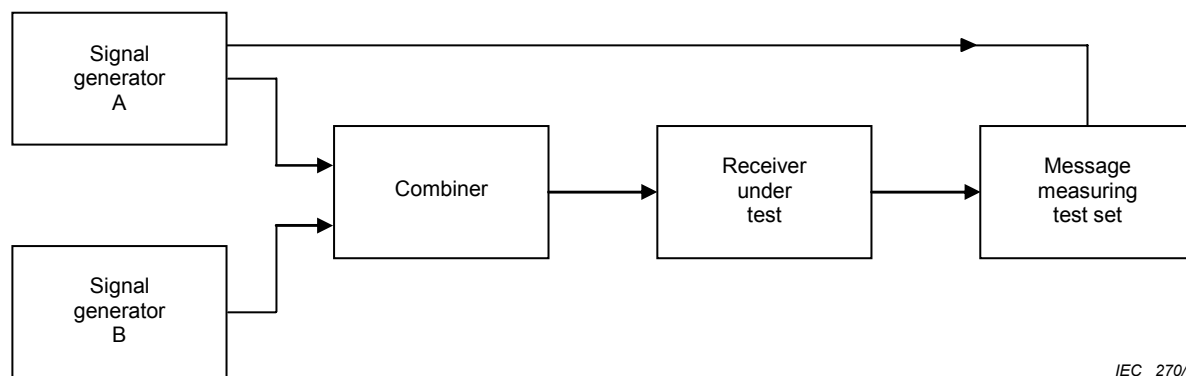

IEC 270/06

Figure 13 – Measurement arrangement with two generators

The measurement procedure shall be as follows:

- a) two generators A and B, shall be connected to the receiver via a combining network;
- b) the wanted signal, provided by signal generator A, shall be at the nominal frequency of the receiver and shall be modulated to generate test signal number 5;
- c) the unwanted signal, provided by generator B, shall also be at the nominal frequency of the receiver. Generator B shall be modulated to generate test signal number 4, either continuously or in the same time period as that used by generator A for test signal number 5. The content of the wanted and unwanted signals shall not be synchronised;
- d) the level of the wanted signal from generator A shall be adjusted to -101 dBm;
- e) the level of the unwanted signal from generator B shall be adjusted to -111 dBm;
- f) the message measuring test set shall be monitored and the packet error rate (*PER*) observed;

- g) the measurement shall be repeated for displacements of the unwanted signal of ± 1 kHz¹¹ from the nominal frequency of the receiver and the *PER* again observed;
- h) the test shall be carried out on the lowest TDMA frequency declared by the manufacturer and AIS 2 (162,025 MHz).

11.2.3.3 Required result

The *PER* shall not exceed 20 %.

11.2.4 Adjacent channel selectivity

11.2.4.1 Definition

The adjacent channel selectivity is a measure of the capability of the receiver to receive a wanted modulated signal without exceeding a given degradation due to the presence of an unwanted signal which differs in frequency from the wanted signal by an amount equal to the adjacent channel separation for which the equipment is intended.

11.2.4.2 Method of measurement

The measurement procedure shall be as follows:

- a) the measurement configuration for co-channel rejection (11.2.3) shall be used;
- b) the wanted signal, provided by signal generator A, shall be at the nominal frequency of the receiver and shall be modulated to generate test signal number 5;
- c) the unwanted signal, provided by generator B, shall be frequency modulated with a 400 Hz sine wave giving a deviation of ± 3 kHz. Generator B shall be at a frequency 25 kHz above that of the wanted signal;
- d) the level of the wanted signal from generator A shall be adjusted to a level of -101 dBm;
- e) the level of the unwanted signal from generator B shall be adjusted to -31 dBm;
- f) the message measuring test set shall be monitored and the packet error rate observed;
- g) repeat the above measurement with the unwanted signal 25 kHz below the wanted signal;
- h) the test shall be carried out on the lowest TDMA frequency declared by the manufacturer and AIS 2 (162,025 MHz).

11.2.4.3 Required results

The *PER* shall not exceed 20 %.

11.2.5 Spurious response rejection

11.2.5.1 Definition

The spurious response rejection is a measure of the capability of the receiver to receive a wanted modulated signal without exceeding a given degradation due to the presence of an unwanted modulated signal at any other frequency, at which a response is obtained.

11.2.5.2 Manufacturers' declarations

The manufacturer shall declare the following in order to calculate the "Limited Frequency Range" over which the initial part of the test will be performed:

- list of intermediate frequencies: $(IF_1, IF_2, \dots, IF_N)$ in Hz;

¹¹ – which is twice the allowable transmit frequency tolerance.

- switching range of the receiver¹²;
- frequency of the local oscillator¹³ at AIS 2 and at the lowest TDMA channel: (f_{LOH}, f_{LOL}) .

11.2.5.3 Introduction to the method of measurement

The initial evaluation of the unit shall be performed over the "Limited Frequency Range" and shall then be performed at the frequencies identified from this test and at "Specific Frequencies of Interest" (as defined below).

To determine the frequencies at which spurious responses can occur the following calculations shall be made:

- a) calculation of the "Limited Frequency Range":

the limits of the limited frequency range (LFR_{HI} LFR_{LO}) are determined from the following calculations:

$$LFR_{HI} = f_{LOH} + (IF_1 + IF_2 + \dots + IF_N + sr/2)$$

$$LFR_{LO} = f_{LOL} - (IF_1 + IF_2 + \dots + IF_N + sr/2)$$

- b) calculation of Specific Frequencies of Interest (*SFI*) outside the limited frequency range:

these are determined by the following calculations:

$$SFI_1 = (K \times f_{LOH}) + IF_1$$

$$SFI_2 = (K \times f_{LOL}) - IF_1$$

where *K* is an integer from 2 to 4.

11.2.5.4 Method of measurement over the Limited Frequency Range

Two methods are available for the measurements over the Limited Frequency Range, one based on SINAD measurements (A) and the other based on *PER* measurements (B). Either method may be used, but in each case shall be followed by the method of measurement at identified frequencies.

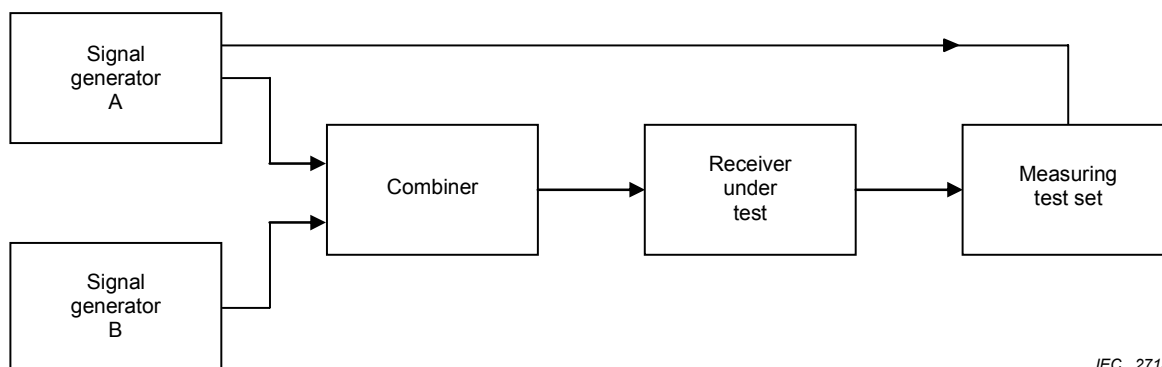

IEC 271/06

Figure 14 – SINAD or PER/BER measuring equipment

¹² Switching range corresponds to the frequency range over which the receiver can be tuned.

¹³ This may be a VCO, crystal, sampling clock, BFO, Numerically Controlled Oscillator depending on the design of the equipment.

11.2.5.4.1 A) Method of search over the "Limited Frequency Range" using SINAD measurement

- a) Two generators A and B shall be connected to the receiver via a combining network.
The wanted signal, provided by generator A, shall be at the nominal frequency of the receiver and shall be modulated with 1 kHz sine wave at $\pm 2,4$ kHz deviation.
The unwanted signal, provided by generator B, shall be frequency modulated with a 400 Hz sine wave giving a deviation of ± 3 kHz.
- b) Initially, generator B (unwanted) shall be switched off (maintaining the output impedance).
The signal level from generator A (wanted) shall be adjusted to -101 dBm at the receiver.
The SINAD value shall be noted (and should be greater than 14 dB)
- c) Signal generator B shall be switched on and adjusted to -27 dBm at the receiver.
- d) The frequency of the unwanted signal shall be varied in steps of 5 kHz over the Limited Frequency Range (from LFR_{LO} to LFR_{HI}).
- e) The frequency of any spurious response detected (by an decrease in SINAD of 3 dB or more) during the search shall be recorded for use in the next measurements.

11.2.5.4.2 B) Method of search over the "Limited Frequency Range" using PER or BER measurement

- a) Two generators A and B, shall be connected to the receiver via a combining network.
The wanted signal, provided by generator A, shall be at the nominal frequency of the receiver and shall be modulated to generate test signal number 5.
The unwanted signal, provided by generator B, shall be frequency modulated with a 400 Hz sine wave giving a deviation of ± 3 kHz.
- b) Initially, generator B (unwanted) shall be switched off (maintaining the output impedance).
The signal level from generator A (wanted) shall be adjusted to -101 dBm at the receiver.
The *PER* or *BER* shall be noted.
- c) Signal generator B shall be switched on and adjusted to -27 dBm at the receiver.
- d) The frequency of the unwanted signal shall be varied in steps of 5 kHz over the Limited Frequency Range (from LFR_{LO} to LFR_{HI})
- e) The frequency of any spurious response detected (by an increase in either *PER* or *BER*) during the search shall be recorded for use in the next measurements.
- f) In the case where operation using a continuous packet stream is not possible a similar method may be used.

11.2.5.5 Method of measurement (at identified frequencies)

- a) Two generators A and B, shall be connected to the receiver via a combining network.
The wanted signal, provided by generator A, shall be at the nominal frequency of the receiver and shall be modulated to generate test signal number 5.
The unwanted signal, provided by generator B, shall be frequency modulated with a 400 Hz sine wave giving a deviation of ± 3 kHz. Generator B shall be at the frequency of that spurious response being considered.
- b) Initially, generator B (unwanted) shall be switched off (maintaining the output impedance).
The signal level from generator A (wanted) shall be adjusted -101 dBm at the receiver.
- c) Generator B shall be switched on, and the level of the unwanted signal set to -31 dBm.
- d) For each frequency noted during the tests over the Limited Frequency Range and the Specific Frequencies of Interest (SFI_1 and SFI_2), transmit 200 packets to the EUT and note the *PER*.

11.2.5.6 Required results

At any frequency separated from the nominal frequency of the receiver by two channels or more, the spurious responses shall not result in a *PER* of greater than 20 %.

11.2.6 Intermodulation response rejection

11.2.6.1 Definition

The intermodulation response rejection is the capability of the receiver to receive a wanted modulated signal, without exceeding a given degradation due to the presence of two close-spaced unwanted signals with a specific frequency relationship to the wanted signal frequency.

11.2.6.2 Method of test

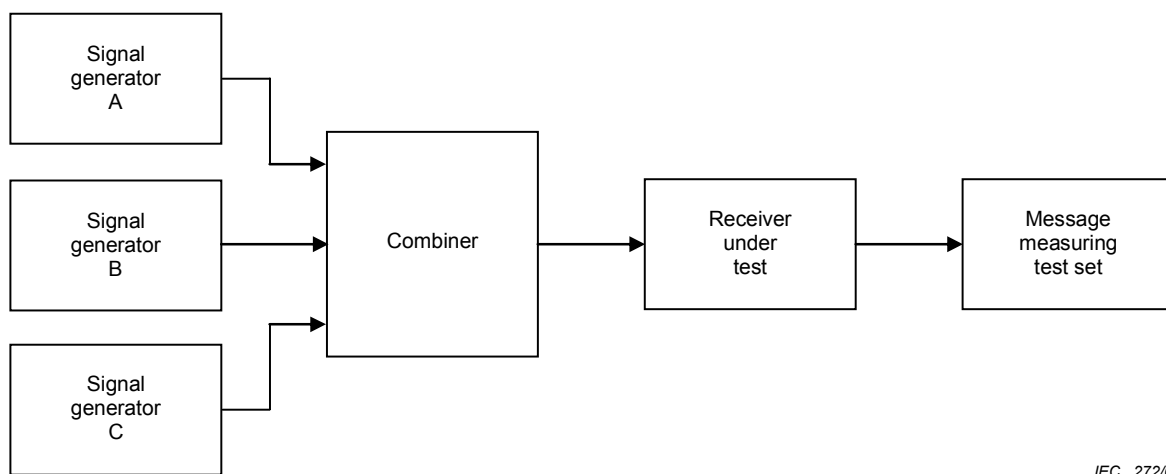

IEC 272/06

Figure 15 – Measurement arrangement for intermodulation

The measurement procedure shall be as follows:

- three signal generators shall be connected to the receiver via a combining network;
- the wanted signal, provided by signal generator A, shall be at the nominal frequency of the receiver and shall be modulated to generate test signal number 5;
- the unwanted signal from generator B shall be unmodulated;
- the unwanted signal from generator C shall be frequency modulated with a 400 Hz sine wave giving a deviation of ± 3 kHz;
- the signal level from generator A (wanted) shall be set for -101 dBm at the receiver input;
- the signal level from generators B and C shall be set for -36 dBm at the receiver input;
- the frequencies of generators A, B, C shall be set as per test #1 of Table 23;
- the message measuring test set shall be monitored and the packet error rate observed;
- repeat the measurement with frequencies set as per tests #2, #3 and #4 of Table 23.

Table 23 – Frequencies for inter-modulation test

	Generator A Wanted AIS signal	Generator B Unmodulated (+/-50 kHz)	Generator C Modulated (+/-100 kHz)
Test #1	162,025 MHz	162,075 MHz	162,125 MHz
Test #2	162,025 MHz	161,975 MHz	161,925 MHz
Test #3	F_{TDMAl_0}	$F_{\text{TDMAl}_0} + 50 \text{ kHz}$	$F_{\text{TDMAl}_0} + 100 \text{ kHz}$
Test #4	F_{TDMAl_0}	$F_{\text{TDMAl}_0} - 50 \text{ kHz}$	$F_{\text{TDMAl}_0} - 100 \text{ kHz}$

NOTE F_{TDMAl_0} is the lowest frequency on which the EUT can operate according to the manufacturer's specification.

11.2.6.3 Required results

The *PER* shall not exceed 20 %.

11.2.7 Blocking or desensitisation

11.2.7.1 Definition

Blocking is a measure of the capability of the receiver to receive a wanted modulated signal without exceeding a given degradation due to the presence of an unwanted input signal at any frequencies other than those of the spurious responses or the adjacent channels.

11.2.7.2 Method of measurement

The measurement procedure shall be as follows:

- two generators A and B, shall be connected to the receiver via a combining network;
- the wanted signal, provided by signal generator A, shall be at the nominal frequency of the receiver and shall be modulated to generate test signal number 5;
- the unwanted signal from generator B shall be unmodulated and shall be at a frequency 0,5 MHz to 10 MHz away from the nominal frequency of the receiver. Measurements shall be carried out at frequencies of the unwanted signal at approximately $\pm 500 \text{ kHz}$, $\pm 1 \text{ MHz}$, $\pm 2 \text{ MHz}$, $\pm 5 \text{ MHz}$ and $\pm 10 \text{ MHz}$, avoiding those frequencies at which spurious responses could occur (see C.4.5);
- initially, signal generator B (unwanted signal) shall be switched off (maintaining the output impedance). The level of the wanted signal from generator A shall be adjusted to -101 dBm at the receiver input;
- the RF signal level for signal generator B (unwanted signal) shall be adjusted to -23 dBm when the frequency setting is less than $\pm 5 \text{ MHz}$. For frequency settings of $\pm 5 \text{ MHz}$ or higher the RF level shall be adjusted to -15 dBm ;
- the test shall be repeated for all the frequencies defined in step c);
- the test shall be carried out on the lowest frequency on which the EUT can operate according to the manufacturer's specification and AIS 2 (162,025 MHz).

11.2.7.3 Required results

The maximum packet error rate shall not exceed 20 %.

11.3 Conducted spurious emissions

11.3.1 Spurious emissions from the receiver

11.3.1.1 Definition

Spurious emissions from the receiver are components at any frequency, conducted to the antenna. The level of spurious emissions shall be measured as their power level in a specified load.

11.3.1.2 Method of measurement

The receiver shall be connected to a 50 Ω attenuator. The output of the attenuator shall be connected to a spectrum analyser or selective voltmeter having an input impedance of 50 Ω . If the detecting device is not calibrated in terms of power input, the level of any detected components shall be determined by a substitution method using a signal generator. The measurement shall extend over the frequency range 9 kHz to 4 GHz.

The receiver shall be switched on, and the measuring receiver shall be tuned over the frequency range 9 kHz to 4 GHz.

At each frequency at which a spurious component is detected, the power level shall be recorded as the spurious level delivered into the specified load.

11.3.1.3 Required results

The power of any spurious emission in the specified range at the antenna terminal shall not exceed -57 dBm (2 nW) in the frequency range 9 kHz to 1 GHz and -47 dBm (20 nW) in the frequency range 1 GHz to 4 GHz.

11.3.2 Spurious emissions from the transmitter

11.3.2.1 Definition

Conducted spurious emissions are emissions on a frequency or frequencies, which are outside the necessary bandwidth and the level of which may be reduced without affecting the corresponding transmission of information. Spurious emissions include harmonic emissions, parasitic emissions, intermodulation products and frequency conversion products, but exclude out-of-band emissions.

11.3.2.2 Method of measurement

The transmitter shall be connected to a 50 Ω power attenuator. The output of the power attenuator shall be connected to a measuring receiver.

If possible, the measurement shall be made with the transmitter unmodulated. If this is not possible, the transmitter shall be modulated by test signal number 4. If possible the modulation should be continuous for the duration of the measurement.

The measurement shall be made over a frequency range from 9 kHz to 4 GHz, excluding the channel on which the transmitter is operating and its adjacent channels.

The resolution bandwidth of the measuring instrument shall be the smallest bandwidth available which is greater than the spectral width of the spurious component being measured. This shall be considered to be achieved when the next highest bandwidth causes less than 1 dB increase in amplitude. Positive peak detection (maximum hold) shall be selected on the spectrum analyser used for this measurement.

A sufficient number of sweeps shall be measured to ensure that the emission profile is developed.

At each frequency at which a spurious component is detected, the power level shall be recorded as the conducted spurious emission level delivered into the specified load, except for the channel on which the transmitter is intended to operate and the adjacent channels.

The conditions used in the relevant measurements shall be recorded in test reports.

11.3.2.3 Required results

The power of any spurious emission on any discrete frequency shall not exceed 0,25 μW (–36 dBm) in the frequency range 9 kHz to 1 GHz and 1 μW (–30 dBm) in the frequency range 1 GHz to 4 GHz.

12 Specific tests of link layer

(see 7.3)

12.1 TDMA synchronisation

12.1.1 Synchronisation test sync mode 1

12.1.1.1 Definition

Synchronisation jitter (transmission timing error) is the time between nominal start of the transmission time period as determined by a UTC synchronisation source ($T_{o, \text{ref}}$) and T_o of the EUT ($T_{o, \text{EUT}}$).

12.1.1.2 Method of measurement

Set up standard test environment and set the EUT to assigned mode for a reporting rate of 5 s. Enable test conditions for the following:

- a) station transmitting Message 1 or 2, 3, 4, 18, 19 not subject to a CS-delay, with repeat indicator = 0, with no propagation delay and with position available is received by the EUT;
- b) no sync source (switched off);
- c) with the internal clock of the EUT out of sync (sync jitter > 1000 μs), transmit messages not to be used as sync source (see 7.3.1.1) to the EUT;
- d) repeat test a) using a sync source transmitting Message 4; simulate the position of the station providing the sync source (for instance a base station 60 NM = 416 μs away from EUT position) in order to simulate a propagation delay;
- e) Repeat test d) with an additional source transmitting Message 1 or 2, 3, 4, 18 not subject to a CS-delay, with repeat indicator = 0, with no propagation delay and with position available is received by the EUT.

Record VDL messages and measure the time between $T_{o, \text{ref}}$ of the synchronisation source and the initiation of the "transmitter on" function T_A and calculate back to $T_{o, \text{EUT}}$ (a sync output may be used for the purpose of this test). Alternative methods, for example by evaluating the start flag are allowed.

12.1.1.3 Required results

- a) The EUT shall synchronise on the received source and the synchronisation jitter shall not exceed $\pm 312 \mu\text{s}$ (sync mode 1).

- b) The synchronisation jitter shall not exceed $\pm 312 \mu\text{s}$ during a 30 s period from the time a proper sync source was last received.
- c) The EUT shall not synchronise on these received messages.
- d) The synchronisation jitter of the EUT shall be within $-416 \mu\text{s} \pm 312 \mu\text{s}$.
- e) The synchronisation jitter of the EUT shall be $-208 \mu\text{s} \pm 312 \mu\text{s}$ within 60 s.

12.1.2 Synchronisation test sync mode 2

12.1.2.1 Method of measurement

Set up standard test environment and enable test conditions for the following:

- a) operate EUT in sync mode 2 for more than 5 min.
- b) Switch on sync source immediately after scheduled transmission of EUT. Sync source shall be a station transmitting Message 1 or 2, 3, 4, 18, 19 not subject to a CS-delay, with repeat indicator = 0 and with position available with a reporting rate of 10 s.

Record VDL messages and measure the time between $T_{o, \text{ref}}$ of the synchronisation source and the initiation of the "transmitter on" function T_A and calculate back to $T_{o, \text{EUT}}$ (a sync output may be used for the purpose of this test). Alternative methods, for example by evaluating the start flag are allowed.

12.1.2.2 Required results

Verify that the EUT synchronises its next scheduled transmission on the sync source. The synchronisation jitter shall not exceed $\pm 312 \mu\text{s}$.

12.1.3 Synchronisation test with UTC

This test is only relevant if optional synchronisation sources providing UTC are implemented.

12.1.3.1 Method of measurement

Set up standard test environment and enable test conditions in a way that EUT operates in UTC synchronised mode.

12.1.3.2 Required results

The synchronisation jitter shall not exceed $\pm 312 \mu\text{s}$.

12.2 Carrier-sense tests

12.2.1 Threshold level

12.2.1.1 Definition

Carrier-sense threshold is the signal level below that which a time period shall be regarded as unused and a transmission may take place.

12.2.1.2 Method of measurement

The test configuration is described here in its most basic form, using three signal sources with RF (PIN) switches selecting when each signal is applied to the EUT. Other equipment configurations may be used if they fulfil the same requirements (for example a single RF source fed via a switched attenuator, which is controlled by a timing circuit).

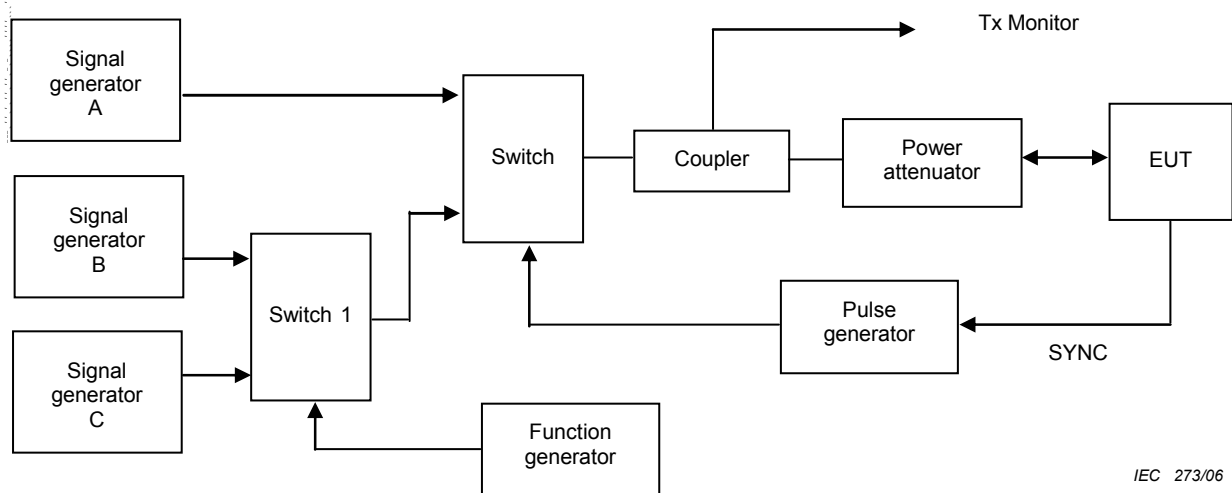

IEC 273/06

Figure 16 – Configuration for carrier-sense threshold test

- Signal C is a carrier modulated with a 400 Hz FM signal with a deviation of 3 kHz equivalent to -60 dBm at the EUT. The switches connect this signal to the EUT most of the time to mimic 100 % channel loading with strong traffic.
- Signal B is a carrier modulated with a 400 Hz FM signal with a deviation of 3 kHz equivalent to -87 dBm at the EUT. Switch 1 replaces signal C with signal B for 26,67 ms. The function generator makes this happen once every 2 s. This imitates one vacant time period in a 99 % loaded channel. The level of Signal B can be manually switched between -87 dBm and OFF to mimic high and low background levels (resulting in a threshold level of -77 dBm and -107 dBm).
- Signal A is a carrier modulated with a 400 Hz FM signal with a deviation of 3 kHz equivalent to -104 dBm at the EUT. When the EUT attempts a transmission, switch 2 replaces the 'background traffic' with signal A to imitate an incoming message intended to inhibit the transmission attempt. The level of signal A can be manually set to -74 dBm, -104 dBm and OFF (defined as less than -117 dBm).
- All three signal generators are tuned to the same frequency. The test shall be carried out on the lowest frequency declared by the manufacturer and AIS 2 (162,025 MHz).
- For the purposes of this test, the EUT will be equipped with a test signal (SYNC) indicating the start of each time period that it intends to transmit into. This is used to trigger the pulse generator which after a delay of 0,8 ms (8 bits) generates a 23,3 ms (224 bits) pulse for switch 2.
- With the signal levels set to the levels shown in the first row of the following table, the EUT shall be observed making routine scheduled position reports. Levels shall then be adjusted as per subsequent steps and the EUT monitored for 10 min (or at least 20 reporting attempts) to confirm if transmission has ceased.

12.2.1.3 Required results

Table 24 – Required threshold test results

Step	Description	Signal A (dBm)	Signal B (dBm)	EUT transmission
1	Time period free	OFF	OFF	Yes
2	Time period used	-104	OFF	Ceased
3	Recovery	OFF	OFF	Yes
4	Raised background	OFF	-87	Yes
5	Time period used	-74	-87	Ceased
6	Recovery	OFF	-87	Yes

12.2.2 Carrier-sense timing

12.2.2.1 Definition

This test is to verify that signals that are received before the CS detection window starts are not used for the detection of used time periods.

12.2.2.2 Method of measurement

Use the test configuration and signals of test 12.2.1.

Signal B is switched off, signal A can be manually set to –74 dBm, –104 dBm and OFF.

The SYNC signal of the EUT indicating the start of each time period that it intends to transmit into is used to trigger the pulse generator to generate a 0,7 ms (7 bits) pulse for switch 2 starting at the SYNC signal (this pulse ends 1 bit before start of the CS detection window of the EUT).

Levels shall be adjusted as per the steps given in Table 25 and the EUT monitored for 10 min (or at least 20 reporting attempts) to confirm if EUT transmits.

12.2.2.3 Required results

Table 25 – Required carrier-sense timing results

Step	Description	Signal A (dBm)	Signal B (dBm)	EUT transmission
1	Time period free	OFF	OFF	Yes
2	Time period free	–104	OFF	Yes
3	Time period free	–74	OFF	Yes

12.3 VDL state/reservations

12.3.1 Method of measurement

Set up standard test environment and operate EUT with assigned reporting interval of 10 s. Record transmitted scheduled position reports Message 18 and check time periods used for transmission.

- a) Transmit a Message 20 to the EUT reserving a block of time periods including timeout.
- b) Transmit a Message 20 to the EUT reserving a block of time periods without timeout.

12.3.2 Required results

- a) Verify that the reserved block is not used and used again after the timeout specified in Message 20.
- b) Verify that the reserved block is not used and used again after a timeout of 3 min.

12.4 Data encoding (bit stuffing)

12.4.1 Method of measurement

Set up standard test environment.

Set ships name to a value that requires bit-stuffing for instance “wwwwww” and check the VDL (note that this might require that the manufacturer provides means to input this data).

12.4.2 Required results

Confirm that transmitted VDL Message 24 conforms to data input.

12.5 Frame check sequence

12.5.1 Method of measurement

Apply simulated position report messages with wrong CRC bit sequence to the VDL.

- a) Check test output; if a display interface is provided, check this.
- b) Repeat test 12.1.1 and check that a station transmitting messages with wrong CRC are not used for synchronisation.

12.5.2 Required results

Confirm that messages with invalid CRC are not accepted by the EUT in cases a) and b).

12.6 Slot allocation (channel access protocol)

12.6.1 Autonomous mode allocation

12.6.1.1 Method of measurement

Set up standard test environment and operate EUT with assigned reporting interval of 10 s. Record transmitted scheduled position reports Message 18 and check time periods used for transmission. Check the communication state of transmitted messages.

Repeat the test with additional simulated channel load of 80 % (4 time periods used, 1 time period unused).

12.6.1.2 Required results

The time periods used for transmission shall in both tests

- not exceed the transmission interval TI;
- not always use the same time period;
- not always use the first unused time period.

Check that the communication state of Message 18 is the default value as defined in 7.3.3.5.

12.6.2 DSC listening periods

12.6.2.1 Method of measurement

This test is applicable only if DSC functionality is implemented.

Set up standard test environment and operate EUT with assigned reporting interval of 10 s. Enable DSC functionality. Record transmitted scheduled position reports Message 18 and check time periods used for transmission.

12.6.2.2 Required results

During the DSC monitoring times, scheduled transmissions of Message 18 shall continue.

12.7 Assigned operation

12.7.1 Assignment priority

12.7.1.1 Method of measurement

Set up standard test environment and operate EUT in autonomous mode. Transmit an Assigned mode command (Message 23) to the EUT with Tx/Rx mode 1.

- a) Transmit a Message 22 defining a region with the EUT inside that region. Transmit a Message 22 to the EUT individually addressed and specifying Tx/Rx mode 2.
- b) Repeat the test, clear the region defined by Message 22 under a) ¹⁴. Transmit Message 22 to the EUT with regional settings specifying Tx/Rx mode 2.

Record transmitted messages.

12.7.1.2 Required results

- a) The Tx/Rx mode field setting of Message 22 shall take precedence over the Tx/Rx mode field setting of Message 23.
- b) The Tx/Rx mode field setting of Message 23 shall take precedence over the Tx/Rx mode field setting of Message 22. The receiving station shall revert to its previous Tx/Rx mode after a timeout value randomly chosen between 240 s and 480 s.

12.7.2 Entering rate assignment

12.7.2.1 Method of measurement

Set up standard test environment and operate EUT in autonomous mode. Transmit a Group Assignment command (Message 23) to the EUT with a reporting interval of 10 s assigned, monitor the VDL, reset by assigning 30 s rate; repeat 10 times.

12.7.2.2 Required result

Verify that the first transmission after receiving the Message 23 is within a time randomly selected between the time the Message 23 has been received and the assigned interval.

12.7.3 Reverting from rate assignment

12.7.3.1 Method of measurement

Set up standard test environment and operate EUT in autonomous mode. Transmit a Group Assignment command (Message 23) to the EUT with a reporting interval of 10 s assigned, monitor the VDL until at least 1 min after timeout occurred; repeat 10 times (transmissions of Message 23 shall not be synchronised to the initial transmission schedule of the EUT).

Measure the time T_{rev} between the reception of Message 23 and first transmission after timeout.

12.7.3.2 Required result

T_{rev} shall be randomly distributed between 240 s and 480 s.

¹⁴ This can be carried out using the method used in 13.3.1 b) step 2 or by assigning a new simulated position to the EUT.

12.7.4 Reverting from quiet mode

12.7.4.1 Method of measurement

Set up standard test environment and operate EUT with a reporting interval of 10 s assigned. Transmit a Group Assignment command (Message 23) to the EUT with quiet time = 1 min.

12.7.4.2 Required results

Verify that the first transmission after the quiet period is within the schedule that was in place before the quiet period.

12.7.5 Retry of interrogation response

12.7.5.1 Method of measurement

Set up standard test environment. Interrogate the EUT by Message 15 for a response with Message 18.

- a) Simulate full VDL load for the following 30 s.
- b) Simulate full VDL load for the following 60 s.

12.7.5.2 Required result

- a) Verify that a response is transmitted between 30 s and 60 s after the transmission of Message 15.
- b) Verify that no response is transmitted.

12.8 Message formats

12.8.1 Received messages

12.8.1.1 Method of measurement

Set up standard test environment and operate EUT in autonomous mode. Apply messages according to Table 11 to the VDL. Record messages output by the PI of EUT where provided.

12.8.1.2 Required results

Confirm that EUT responds as appropriate. Check that EUT outputs the corresponding sentences with correct field contents and format via the PI where provided.

Verify that the EUT does not process addressed messages.

12.8.2 Transmitted messages

12.8.2.1 Method of measurement

Set up standard test environment and operate EUT in autonomous mode. Initiate the transmission of messages relevant for a Class B mobile station according to Table 11 by the EUT. Record transmitted messages.

12.8.2.2 Required results

Confirm that only messages as allowed by Table 11 are transmitted by the EUT.

12.8.3 Use of safety related Message 14

This test is only applicable if Message 14 is implemented.

12.8.3.1 Method of measurement

Check manufacturer's documentation.

- a) Initiate transmission of Message 14 as specified by the manufacturer.
- b) Repeat initiation twice a minute.

12.8.3.2 Required results

- a) Verify that the data content of Message 14 is predefined and the transmission cannot exceed one time period (see Table 12).
- b) Verify that the EUT only accepts the initiation of a Message 14 once a minute without automatic repetition.

13 Specific tests of network layer

(see 7.4)

13.1 Regional area designation by VDL message

13.1.1 Method of measurement

Set up standard test environment. Apply channel management messages (Message 22) to the VDL defining two adjacent regional areas 1 and 2 with different channel assignments for both regions and a transitional zone extending 4 NM either side of the regional boundary

Let the EUT approach region 1 from outside region 2 more than 5 NM away from region boundary transmitting on default channels. Record transmitted messages on all 6 channels. This can be accomplished by either using a dedicated test input for simulated position information or a GNSS simulator.

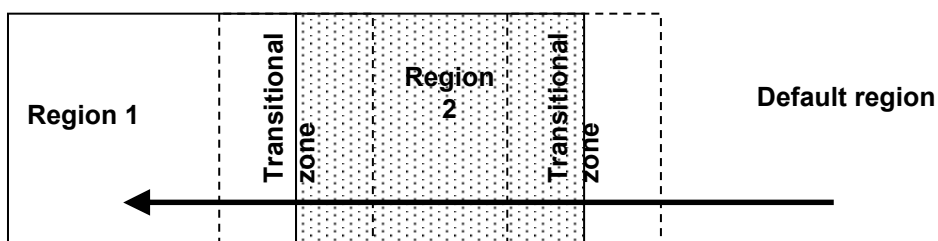

IEC 274/06

	Primary channel	Secondary channel
Region 1	CH A 1	CH B 1
Region 2	CH A 2	CH B 2
Default region	AIS 1	AIS 2

Figure 17 – Regional area scenario

13.1.2 Required results

Check that the EUT transmits and receives on the primary channels assigned for each region alternating channels and doubling reporting rate when passing through the transitional zones (see Table 26). EUT shall revert to default autonomous operation on the regional channels after leaving the transitional zones.

Table 26 – Required channels in use

	Area	Channels in use
1	Default region	AIS 1, AIS 2
2	First transitional zone	AIS 1, CH A 2
3	Region 2	CH A 2, CH B 2
4	Second transitional zone	CH A 2, CH A 1
5	Region 1	CH A 1, CH B 1

13.2 Regional area designation by serial message or manually

13.2.1 Method of measurement

Check documentation.

13.2.2 Required result

Verify that the user cannot allocate channels (directly or by ACA sentence).

13.3 Management of received regional operating settings

13.3.1 Replacement or erasure of dated or remote regional operating settings

13.3.1.1 Method of measurement

Set up standard test environment. Send a valid regional operating setting to the EUT by Message 22 with the regional operating area including the own position of the EUT. Consecutively send a total of seven valid regional operating settings to EUT, using Message 22, with regional operating areas not overlapping to the first and to each other. Perform the following in the order shown:

- a) send a ninth Message 22 to the EUT with valid regional operating areas not overlapping with the previous eight regional operating areas;
- b) Step 1: set own position of EUT into any of the regional operating areas defined by the second to the ninth Message 22 sent to the EUT previously;
Step 2: send a tenth Message 22 to the EUT, with a regional operating area which partly overlaps the regional operating area to which the EUT was set by step 1 but which does not include the own position of the EUT;
- c) Step 3: move own position of EUT to a distance of more than 500 miles from all regions defined by previous commands;
Step 4: consecutively set own position of EUT to within all regions defined by the previous Message 22.

This test can be accomplished by either using the test input for simulated position information or a GNSS simulator (see also Annex D).

13.3.1.2 Required results

After the initialisation, the EUT shall operate according to the regional operating settings defined by the first Message 22 sent.

- a) The EUT shall return to the default operating settings.
- b) Step 1: check that the EUT changes its operating settings to those of that region which includes own position of the EUT.

Step 2: check that the EUT reverts to the default operating settings.

NOTE Since the regional operating settings to which the EUT was set in Step 1 are erased due to Step 2, and since there is no other regional operating setting due to their non-overlapping definition, the EUT returns to default.

- c) Step 3: check that the EUT operates with the default settings.

Step 4: check that the EUT operates with the default settings.

13.3.2 Channel management by addressed Message 22

13.3.2.1 Method of measurement

Set up a standard test environment and operate EUT in autonomous mode. Perform the following tests in the following order:

- a) send Message 22 with valid regional operating settings that are different from the default operating settings to the EUT with a regional operating area, which contains the current position of own station;
- b) send an addressed Message 22 to the EUT with different regional operating settings than the previous command;
- c) move the EUT out of the regional operating area defined by the previous addressed command into an area without regional operating settings.

13.3.2.2 Required results

- a) Check, that the EUT uses the regional operating settings commanded to it in a).
- b) Check, that the EUT uses the regional operating settings commanded to it in b).
- c) Check, that the EUT reverts to default.

13.3.3 Invalid regional operating areas

This test is to check the rejection of invalid regional operating areas (three regional operating areas with same corner).

13.3.3.1 Method of measurement

Set up standard test environment and operate EUT in autonomous mode. Perform the following tests in the following order after completion of all other tests related to change of regional operating settings:

- a) send three different valid regional operating settings with adjacent regional operating areas, their corners within eight miles of each other, to the EUT by Message 22. The current own position of the EUT shall be within the regional operating area of the third regional operating setting;
- b) move current own position of the EUT consecutively to the regional operating areas of the first two valid regional operating settings.

13.3.3.2 Required test results

- a) Check, that the EUT uses the operating settings that were in use prior to receiving the third regional operating setting.
- b) Check, that the EUT consecutively uses the regional operating settings of the first two received regional operating areas.

13.3.4 Continuation of autonomous mode reporting rate**13.3.4.1 Method of test**

When in the presence of an assigned mode command and in a transition zone, check that the EUT continues to report at the autonomous mode reporting interval.

13.3.4.2 Required result

Ensure that the autonomous reporting interval is maintained.

13.3.5 Other conditions

The fulfilment of all other conditions of 7.4.2 shall be self-certified by the manufacturer.

Annex A (informative)

Results of computer simulations and testing of CSTDMA technology

A.1 Computer simulations

Computer simulations were conducted in the United States simulating 150 ships fitted with Class A AIS sailing in the San Francisco area and a further 700 ships fitted with Class B AIS thus loading the VHF data link to about 50 % capacity. The Class A AIS conformed to IEC 61993-2 with a power output of 12,5 W and an antenna height of 30 m. The Class B AIS conformed to this standard with a power output of 1 W and an antenna height of 6 m. The simulations initially studied the effect on the Class A AIS of the Class B messages. Figure A.1 below summarises the results showing the loss of messages from Class A AIS with the range of vessels from own ship when no Class B AIS are transmitting and the effect of adding in the Class B AIS. It can be seen that there is very little effect on the Class A AIS so the CSTDMA technology adheres to the spirit of IMO Resolution MSC.140(76) concerning protection of the VHF data link.

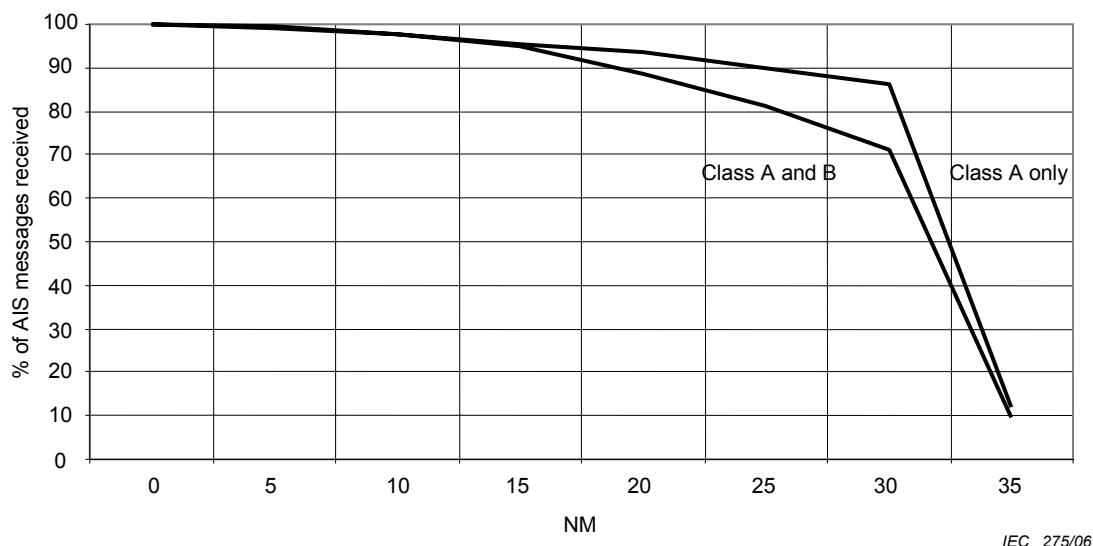

Figure A.1 – Effect on Class A AIS messages of Class B messages

The simulations then studied the probability of the Class A AIS receiving messages from the Class B AIS. The range from own ship attainable would be expected to be less than for Class A messages because of the lower power, the lower antenna height and the collision rate of the Class B messages. Figure A.2 summarises the results showing a useable range out to perhaps 15 NM.

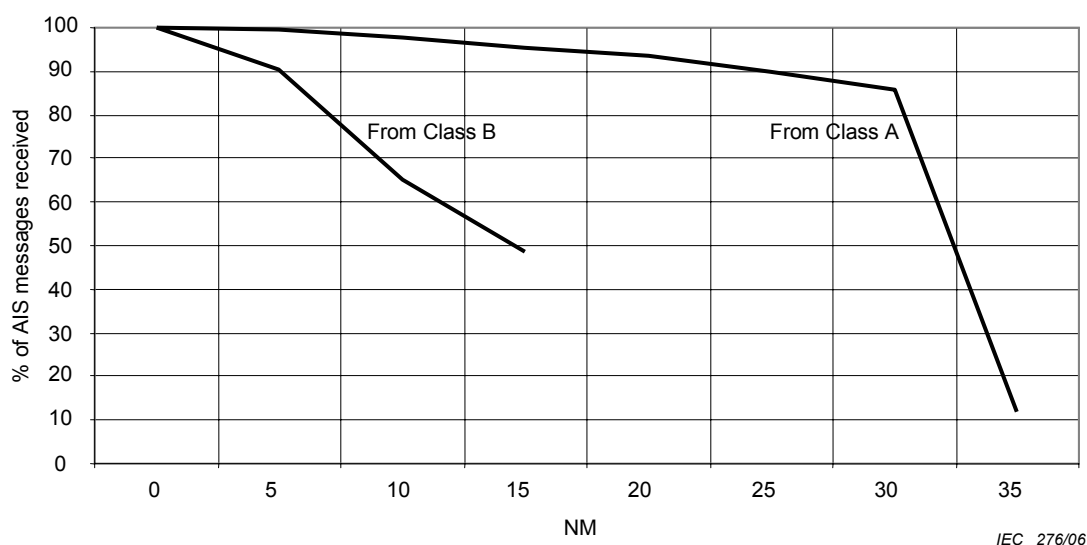

Figure A.2 – Reception of messages by Class A AIS

Finally, the simulations studied the performance of the Class B AIS as a receiver. The achieved range of Class A messages was less due to the lower antenna height and the range of the Class messages was similarly reduced giving a useable range out to perhaps 10 NM.

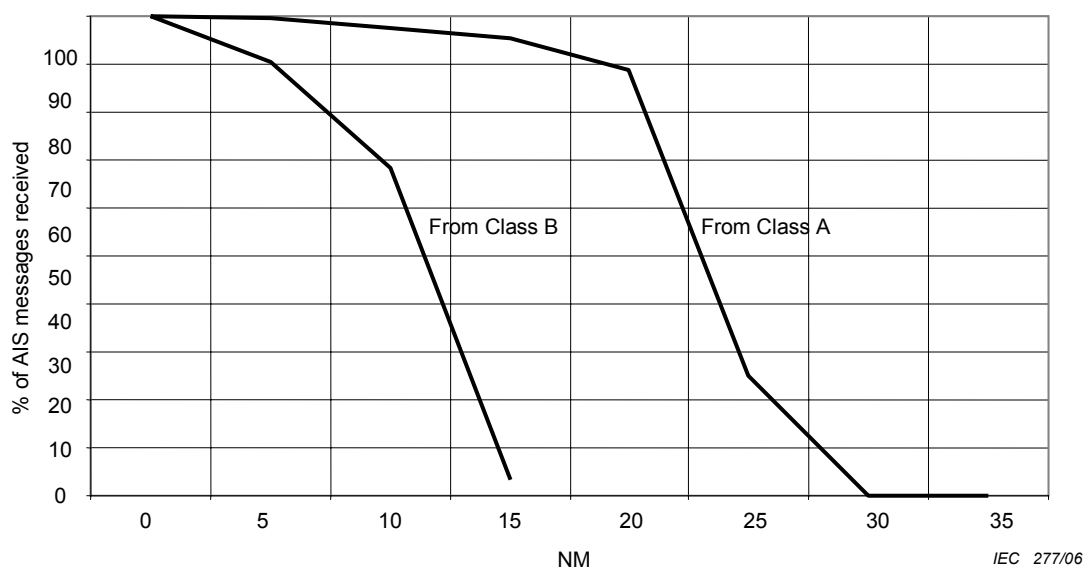

Figure A.3 – Reception of messages by Class B AIS

In conclusion therefore, the simulations showed that CSTDMA would work in a non-intrusive way with Class A AIS and Class B AIS conforming to this standard would produce a useful range for both large and small vessels.

A.2 Carrier-sense tests

Tests were carried out in Germany in a laboratory using a Class A AIS loaded to 50 % channel capacity with a Message 1 (position report) in each even slot. Three Class B AIS then commenced transmission. Over a period of an hour there were 241 Message 18 (Class B position report) transmissions and all occurred in the free (odd) slots which showed that the carrier-sense detection method of this standard operated correctly.

Tests were then carried out with the three different Class B AIS prototypes installed on a ship (the research vessel Gauss). The ship sailed in the Baltic Sea where other ships were transmitting AIS messages. The total test time was around 13 h while both moving and at anchor and some 115 000 messages were received at a channel loading of 3,5 %. There were 6889 Class B Message 18 transmissions in this time and these were analysed to look for possible clashes. A total of 13 were found to have clashed with Class A AIS transmissions or 0,19 % of the total. Further investigation found that 8 out of 13 clashes derived from the same Class B AIS so this prototype did not work as well as the other two and could be subject to improvement. 8 of the clashes also occurred at the range limit receive level of -107 dBm where performance may be expected to be marginal and 3 occurred due to misoperation of the Class A AIS. It would appear from this trial therefore that false operation of the Carrier-Sense detection mechanism will be limited to less than 0,1 % of transmissions.

A.3 Range tests

Range tests were conducted with three prototype Class B AIS to a Class A AIS receiver on the research vessel Gauss with an antenna at a height of 15 m. AIS 1 in Figure A.4 below was mounted on a moored dinghy with an antenna height of 5 m. AIS 2 and 3 were mounted on a vehicle on the shore side with antenna heights between 5 m and 6 m. The AIS power output was 1 W. The results were found to vary by ±10 % with the aspect of the vessel Gauss due to shadowing of the VHF antennas on board. The values shown on Figure A.4 are average values. If 50 % of messages received is taken as a useable threshold, then useful ranges were achieved out to about 7 NM. This is somewhat less than was predicted by the earlier computer simulations and can be expected to be less again for a case of the Class B AIS receiver with the lower antenna height, so the recommended power output in this standard has been increased to 2 W.

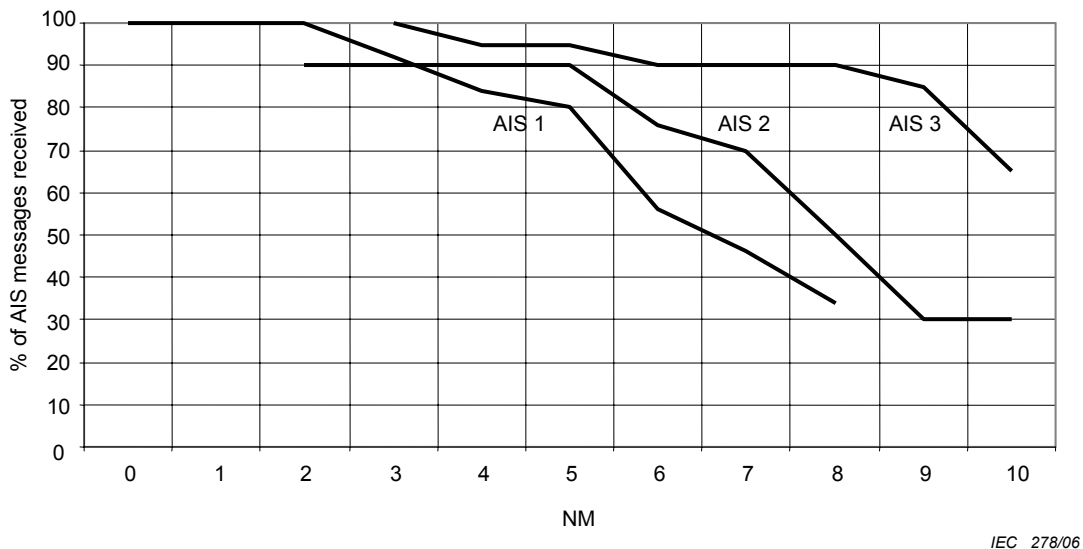

Figure A.4 – Range achieved by a Class A AIS from Class B AIS

A.4 Conclusion

In conclusion therefore, simulations and testing of prototypes has shown that Class B CSTDMA AIS will interwork with Class A AIS, that the carrier-sense mechanism will cause negligible degradation to Class A operation and that ranges of the order of 7 NM will be achieved from a 2 W transmitter.

Annex B (informative)

Description of the system

Class B AIS equipment built to this standard is compatible with Class A AIS equipment built to IEC 61993-2. This Class B AIS using CSTDMA receives all the information available from other ships and safety messages exactly as a Class A AIS.

The differences in equipment operation with this standard compared to IEC 61993-2 are:

- this Class B, whilst analysing the slot transmissions of all other ships in radio range, cannot pre-assign slots but simply transmits when a slot is free. This limits the transmitted message to a single slot which in practice means that this Class B can transmit a position report including the MMSI of the vessel just as Class A but cannot transmit the extended Message 5 which gives the other ship information – name, call sign, etc. This Class B also cannot transmit safety messages;
- this Class B uses the Message 18 for the position report which is defined in ITU-R Recommendation M.1371-1 and which can be read by all Class A AIS. Some bits in Message 18 which have not been defined, being spare or reserved, are defined in this standard for the transmission of some specific Class B engineering information mainly concerning frequency management which may be useful to Base Stations;
- this standard also defines two new single slot messages which transmit at 6 minute intervals giving the other ship information. These are not however readable by Class A equipment but can be read by other Class B of this type and suitably equipped Base Stations;
- this standard specifies a transmitter power of 2 W compared to the 12,5 W of Class A in order to reduce equipment costs. This provides a range up to about 7 NM;
- this standard requires a built in GPS (so that an external GPS is not a requirement) and does not need any other sensors (such as the heading input required of the Class A). It also does not need the Minimum Keyboard Display of the Class A since there is no user definable data to input. However it does provide an optional external interface for input data where provided by the manufacturer;
- to alleviate concerns about possible overloading of the AIS channels by large numbers of Class B devices this standard limits the maximum transmission update interval to 30 s compared with 2 s for Class A and adds a special message for use by shore based competent authorities who can switch these Class B devices off.

Annex C (normative)

DSC channel management

C.1 DSC functionality

The AIS shall be capable of performing regional channel designation and regional area designation as defined in ITU-R M.1371-1, Annex 3; DSC transmissions (acknowledgements or responses) shall not be broadcast.

The DSC functionality shall be accomplished by using a dedicated DSC receiver or by time sharing the TDMA channels. The primary use of this feature is to receive channel management messages when AIS 1 and/or AIS 2 are not available.

C.2 DSC time sharing

In the case of equipment which implements the DSC receive function by time sharing the TDMA receive channels, the following shall be observed.

One of the receive processes shall monitor DSC channel 70 for the 30 s time periods in Table C.1. This selection shall be swapped between the two receive processes.

If the AIS is utilising this time sharing method to receive DSC, AIS transmissions shall still be performed during this period. In order to accomplish the CS algorithm, the AIS receivers' channel switching time shall be such that the DSC monitoring is not interrupted for more than 0,5 s per AIS transmission.¹⁵

If a DSC command is received, the AIS transmission may be delayed accordingly.

These periods shall be programmed into the unit during its configuration. Unless some other monitoring schedule is defined by a competent authority, the default monitoring times in Table C.1 shall be used. The monitoring schedule shall be programmed into the unit during initial configuration. During the DSC monitoring times, scheduled autonomous or assigned transmissions, and responses to interrogations shall continue.

The AIS device shall be capable of processing message type 104 with expansion symbols No. 00, 01, 09, 10, 11, 12, and 13 of Table 5 of Recommendation ITU-R M.825 (DSC Channel Management test signal number 1 for this test) by performing operations in accordance with ITU-R M.1371-1 Annex 2, 4.1 with the regional frequencies and regional boundaries specified by these calls.

¹⁵ During the DSC monitoring periods, TDMA receptions will necessarily be disrupted due to this time sharing of the AIS receiver. Proper performance of the AIS assumes that DSC Channel Management messages are transmitted in compliance with Recommendation ITU-R M.825 which requires duplicate messages with a gap of 0,5 s between the two transmissions. This will insure that the AIS can receive at least one DSC channel management message during each DSC monitoring time without any affects to its AIS transmit performance.

Table C.1 – DSC monitoring times

Minutes past UTC hour
05:30 – 05:59
06:30 – 06:59
20:30 – 20:59
21:30 – 21:59
35:30 – 35:59
36:30 – 36:59
50:30 – 50:59
51:30 – 51:59
NOTE Refer to ITU-R M.1371-1, Annex 3, Clause 1.

For test purposes, the unit may be placed into a mode, which monitors DSC every minute. Entry to this mode shall not be available to the end-user.

Means shall be provided to disable DSC monitoring during setup.

C.3 DSC functionality tests

C.3.1 General

For the tests in this clause (see also IEC 61993-1), set the EUT into assigned mode using channels AIS 1 and AIS 2 with a reporting interval of 10 s.

Check with a sequence of valid calls consisting of a DSC channel management test signal number 1, a geographic call from ITU-R M.493, a test signal number 1, an individual call from ITU-R M.493 and a test signal number 1 that the EUT's AIS operation is not affected by the interleaved calls.

C.3.2 Regional area designation

Perform the following tests using the DSC channel management test signal number 1.

Send to the EUT a standard test signal number 1 but with symbol numbers appropriate to the geographical regions and channels specified in the test. Note the transition boundary is 5 NM in this test.

C.3.3 Scheduling

Check that the EUT's AIS reporting is not affected during the DSC monitoring times.

Send a valid geographical call to the EUT. Check that a response is not transmitted.

C.3.4 DSC flag in Message 18

Check that the DSC flag is set properly when DSC functionality is available.

C.3.5 DSC monitoring time plan

Check that DSC commands are received during DSC monitoring times and, if time-sharing is used, are not received outside those times.

C.3.6 Replacement or erasure of dated or remote regional operating settings

Method of measurement

Set up standard test environment. Send a valid regional operating setting to the EUT by Message 22 with the regional operating area including the own position of the EUT. Consecutively send a further seven (7) valid regional operating settings to EUT, using both Message 22 and DSC telecommands, with regional operating areas not overlapping to the first and to each other. Perform the following in the order shown:

- a) send a ninth Message 22 to the EUT with valid regional operating areas not overlapping with the previous eight regional operating areas;
- b) Step 1: set own position of EUT into any of the regional operating areas defined by the second to the ninth telecommands sent to the EUT previously;
Step 2: send a tenth telecommand to the EUT, with a regional operating area which partly overlaps the regional operating area to which the EUT was set by Step 1 but which does not include the own position of the EUT;
- c) Step 1: move own position of EUT to a distance of more than 500 NM from all regions defined by previous commands;
Step 2: consecutively set own position of EUT to within all regions defined by the previous telecommands.

Required results

After the initialisation, the EUT shall operate according to the regional operating settings defined by the first Message 22 sent.

- a) The EUT shall return to the default operating settings.
- b) Step 1: check that the EUT changes its operating settings to those of that region which includes own position of the EUT.
Step 2: check that the EUT reverts to the default operating settings.

NOTE Since the regional operating settings to which the EUT was set in Step 1 are erased due to Step 2, and since there is no other regional operating setting due to their non-overlapping definition, the EUT returns to default.
- c) Step 1: check that the EUT operates with the default settings.
Step 2: check that the EUT operates with the default settings.

C.3.7 Test of addressed telecommand

Method of measurement

Set up a standard test environment and operate EUT in autonomous mode. Perform the following tests in the following order:

- a) send a DSC telecommand with valid regional operating settings that are different from the default operating settings, to the EUT with a regional operating area, which contains the current position of own station;
- b) send an addressed DSC telecommand to the EUT with different regional operating settings than the previous command;
- c) move the EUT out of the regional operating area defined by the previous addressed telecommand into an area without regional operating settings.

Required results

- a) Check, that the EUT uses the regional operating settings commanded to it in a).
- b) Check, that the EUT uses the regional operating settings commanded to it in b).
- c) Check, that the EUT reverts to default.

C.3.8 Invalid regional operating areas

Test for invalid regional operating areas (three regional operating areas with same corner).

Method of measurement

Set up standard test environment and operate EUT in autonomous mode. Perform the following tests in the following order after completion of all other tests related to change of regional operating settings:

- a) send three different valid regional operating settings with adjacent regional operating areas, their corners within eight miles of each other, to the EUT by DSC telecommand, Presentation interface input and manual input via MKD. The current own position of the EUT shall be within the regional operating area of the third regional operating setting;
- b) move current own position of the EUT consecutively to the regional operating areas of the first two valid regional operating settings.

This test can be accomplished by either using a dedicated test input for simulated position information or a GNSS simulator.

Required test results

- a) Check, that the EUT uses the operating settings that were in use prior to receiving the third regional operating setting.
- b) Check, that the EUT consecutively uses the regional operating settings of the first two received regional operating areas.

C.4 DSC receiver tests

In the case of a time-shared DSC receiver, the EUT will need to be placed into a test mode that enables continuous reception of the DSC signals. If the manufacturer declares that the receiver is identical to the TDMA receiver, then tests C.4.1 to C.4.7 may be waived at the discretion of the test house and this fact noted in the test report.

C.4.1 Maximum sensitivity

Definition

The maximum sensitivity of the receiver is the minimum level of the signal dBm at the nominal frequency of the receiver which when applied to the receiver input with a test modulation will produce a bit error rate of 10^{-2} .

Method of measurement

The wanted signal shall be standard test signal number 1. The EUT shall provide a logic level test output from its internal DSC demodulator to measure bit error rate. Alternatively, packet error rate may be measured and interpreted back into bit error rate by calculation. The test shall be repeated at the nominal carrier frequency ($156,525 \text{ MHz} \pm 1,5 \text{ kHz}$)

Required result

Ensure that the maximum usable sensitivity does not exceed -107 dBm under normal test conditions, and -101 dBm under extreme test conditions.

C.4.2 Error behaviour at high input levels

Definition

The dynamic range of the equipment is the range from the minimum to the maximum level of a radio frequency input signal at which the bit error rate in the output of the receiver does not exceed a specified value.

Method of measurement

A test signal, in accordance with standard test signal number 1, shall be applied to the receiver input. The level of the test signal shall be -7 dBm.

Required result

The *BER* shall not exceed 10^{-2} .

C.4.3 Co-channel rejection

Definition

The co-channel rejection is a measure of the capability of the receiver to receive a wanted modulated signal without exceeding a given degradation due to the presence of an unwanted modulated signal, both signals being at nominal frequency of the receiver.

Method of measurement

The wanted signal shall be standard test signal number 1. The level of the wanted signal shall be -104 dBm.

The unwanted signal shall be modulated by 400 Hz with a deviation of ± 3 kHz. The input level of the unwanted signal shall be -114 dBm.

Both input signals shall be at the nominal frequency of the receiver under test and the measurement shall be repeated for displacements of the unwanted signal of up to ± 3 kHz.

Required result

The *BER* shall not exceed 10^{-2} .

C.4.4 Adjacent channel selectivity

Definition

The adjacent channel selectivity characterises the capability of the receiver to receive a wanted modulated signal without exceeding a given degradation due to the presence of an unwanted modulated signal that differs in frequency from the wanted signal by 25 kHz.

Method of measurement

The wanted signal shall be standard test signal number 1. The level of the wanted signal shall be -104 dBm.

The unwanted signal shall be modulated by 400 Hz with a deviation of ± 3 kHz. The input level of the unwanted signal shall be -34 dBm. The unwanted signal shall be tuned to the centre frequency of the upper adjacent channel.

The measurement shall be repeated with the unwanted signal tuned to the centre frequency of the lower adjacent channel.

Required result

The adjacent channel selectivity for a *BER* not exceeding 10^{-2} shall be not less than 70 dB under normal test conditions and not less than 60 dB under extreme test conditions.

C.4.5 Spurious response rejection**Definition**

The spurious response characterises the capability of the receiver to receive a wanted modulated signal without exceeding a given degradation due to the presence of an unwanted modulated signal with frequencies outside the band of the receiver.

Method of measurement

The wanted signal shall be standard test signal number 1. The level of the wanted signal shall be -104 dBm.

The unwanted signal shall be unmodulated. The frequency range shall be calculated in the same manner as in 11.2.5. The level of the unwanted signal shall be -34 dBm.

Required result

The *BER* shall not exceed 10^{-2} .

C.4.6 Intermodulation response rejection**Definition**

The intermodulation response ratio characterises the capability of the receiver to receive a wanted modulated signal without exceeding a given degradation due to the presence of two or more unwanted signals with a specific frequency relationship to the wanted signal frequency.

Method of measurement

The wanted signal represented by signal generator A shall be at the nominal frequency of the receiver and shall be standard test signal number 1. The level of the wanted signal shall be -104 dBm.

The unwanted signal from signal generator B shall be unmodulated and adjusted to a frequency 50 kHz above the nominal frequency of the receiver. The second unwanted signal from signal generator C shall be modulated by 400 Hz with a deviation of ± 3 kHz and adjusted to a frequency 100 kHz above the nominal frequency of the receiver. The input level of each unwanted signal shall be -39 dBm. The test shall be repeated with the frequency of the unwanted signals below the nominal frequency of the receiver.

Required result

The *BER* shall not exceed 10^{-2} (for an intermodulation response rejection ratio of 65 dB).

C.4.7 Blocking or desensitisation**Definition**

The blocking immunity characterises the capability of the receiver to receive a wanted modulated signal without exceeding a given degradation due to the presence of an unwanted modulated signal with frequencies outside the band of the receiver.

Method of measurement

The wanted signal shall be standard test signal number 1. The level of the wanted signal shall be –104 dBm.

The unwanted signal shall be unmodulated. The frequency shall be varied between –10 MHz and –1 MHz and also between +1 MHz and +10 MHz relative to the nominal frequency of the wanted signal. The level of the unwanted signal shall be –20 dBm.

Required result

The *BER* shall not exceed 10^{-2} .

Annex D (informative)

Channel management regions

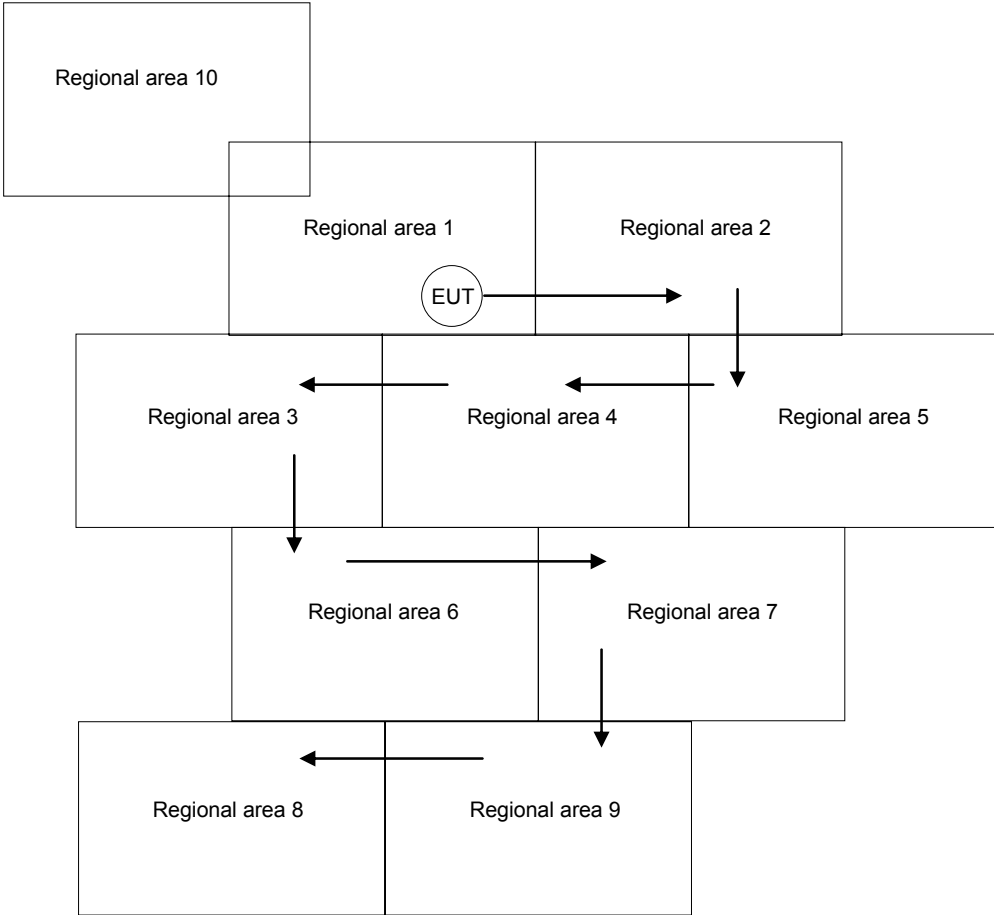

IEC 279/06

Figure D.1 – Channel management regions used for test given in 13.3.1





Standards Survey

The IEC would like to offer you the best quality standards possible. To make sure that we continue to meet your needs, your feedback is essential. Would you please take a minute to answer the questions overleaf and fax them to us at +41 22 919 03 00 or mail them to the address below. Thank you!

Customer Service Centre (CSC)

International Electrotechnical Commission

3, rue de Varembé
1211 Genève 20
Switzerland

or

Fax to: **IEC/CSC** at +41 22 919 03 00

Thank you for your contribution to the standards-making process.

A Prioritaire

Nicht frankieren
Ne pas affranchir



Non affrancare
No stamp required

RÉPONSE PAYÉE

SUISSE

Customer Service Centre (CSC)
International Electrotechnical Commission
3, rue de Varembé
1211 GENEVA 20
Switzerland



Q1 Please report on **ONE STANDARD** and **ONE STANDARD ONLY**. Enter the exact number of the standard: (e.g. 60601-1-1)

.....

Q2 Please tell us in what capacity(ies) you bought the standard (tick all that apply). I am the/a:

- purchasing agent
- librarian
- researcher
- design engineer
- safety engineer
- testing engineer
- marketing specialist
- other.....

Q3 I work for/in/as a: (tick all that apply)

- manufacturing
- consultant
- government
- test/certification facility
- public utility
- education
- military
- other.....

Q4 This standard will be used for: (tick all that apply)

- general reference
- product research
- product design/development
- specifications
- tenders
- quality assessment
- certification
- technical documentation
- thesis
- manufacturing
- other.....

Q5 This standard meets my needs: (tick one)

- not at all
- nearly
- fairly well
- exactly

Q6 If you ticked NOT AT ALL in Question 5 the reason is: (tick all that apply)

- standard is out of date
- standard is incomplete
- standard is too academic
- standard is too superficial
- title is misleading
- I made the wrong choice
- other

Q7 Please assess the standard in the following categories, using the numbers:

- (1) unacceptable,
- (2) below average,
- (3) average,
- (4) above average,
- (5) exceptional,
- (6) not applicable

- timeliness.....
- quality of writing.....
- technical contents.....
- logic of arrangement of contents
- tables, charts, graphs, figures.....
- other

Q8 I read/use the: (tick one)

- French text only
- English text only
- both English and French texts

Q9 Please share any comment on any aspect of the IEC that you would like us to know:

.....



.....

ISBN 2-8318-8523-X



9 782831 885230

ICS 47.020.70

Typeset and printed by the IEC Central Office
GENEVA, SWITZERLAND